



International Sailing Federation

The Racing Rules of Sailing Q & A's Booklet

Last update: 7 July 2010

Ariadne House, Town Quay, Southampton, Hampshire SO14 2AQ, UK

Tel +44 (0)23 80 635111
Fax + 44 (0)23 80 635789
Email secretariat@isaf.co.uk
www.sailing.org

ISAF (UK) Ltd is a company limited by guarantee and registered in England under Number 3255744

Introduction

The ISAF Racing Rules Questions and Answers are published on the ISAF website as a joint responsibility of the Racing Rules Committee and the Race Officials Committee.

The answers are prepared by experienced Race Officials and are intended to provide a service to Race Officials, Member National Authorities and ISAF Class Associations whereby they may submit questions through ISAF concerning the Racing Rules of Sailing (RRS).

The answers are not authoritative interpretations and explanations of the RRS, but nevertheless represent an important service by providing carefully considered opinions of experienced Race Officials.

It is intended that these questions and answers are further considered for inclusion in the ISAF Case Book/Call Books.

This service is not to be used as a 'substitute' appeal process, but is simply to provide considered opinions on questions on the RRS.

Our thanks to Tony Mooney (AUS) for acting as Chairman of the Panel, to the Race Officials who work on providing these opinions and to Marianne Middelthon (NOR) for preparing this booklet of Questions and Answers.

Charley Cook
Chairman
ISAF Race Officials Committee
April 2010

David Tillett
Chairman
ISAF Racing Rules Committee
April 2010



ISAF Racing Rules Question and Answer Service

Contents by Sections

A - Fair Sailing

A 1	Q&A 07-008	Slowing another boat's progress in a race.
A 2	Q&A 09-023	A discussion about different aspects of a situation when a boat learns, in an invalid hearing, that she has broken a rule.

B - Boat vs Boat

B 1	Q&A 06-005	A collision between two catamarans on opposite tacks at a narrow gate.
B 2	Q&A 09-004	'Keeping Clear' in a windward /leeward situation.
B 3	Q&A 09-017	When Mark-Room includes room to tack.
B 4	Q&A 09-021	Rights and obligations at obstructions.
B 5	Q&A 09-022	How much room is mark-room?
B 6	Q&A 09-025	Questions about the windward mark and proper course.
B 7	Q&A 09-028	Obligations when a boat hails for room to tack.
B 8	Q&A 09-030	A clarification about rule 18.3.
B 9	Q&A 09-033	How early must a boat start taking action to avoid a collision?
B 10	Q&A 09-036	When does rule 18.3 stop applying?
B 11	Q&A 10-001	3 boats overlapped on port tack approaching an obstruction; a racing boat on starboard tack.
B 12	Q&A 10-009	Finishing mark and rules 18.2 and 18.5.
B 13	Q&A 10-011	Overlap changing from leeward to windward overlap.
B 14	Q&A 10-012	Rule 18.3 and 'causing a boat to sail above close-hauled'.
B 15	Q&A 10-013	Rules 19 and 20 when multiple boats meet.
B 16	Q&A 10-017	Windward boat must always keep clear.
B 17	Q&A 10-020	Two boats tacking in the zone when another is fetching.

B 18	Q&A 10-025	Clarifications about Mark-Room and rule 18.3.
------	------------	---

C – Starting

C 1	Q&A 07-004	A clarification about rule 30.1, I Flag Rule (Called Round-an-End Rule).
C 2	Q&A 09-027	When boats start in both directions – what should be done?

D – Sailing the Course

D 1	Q&A 09-008	'Side of a mark' for the purpose of rule 28.
D 2	Q&A 09-010	A boat forced to the wrong side of a mark still needs to sail correctly around that mark. She is not 'compelled' to break rule 28.
D 3	Q&A 09-014	A clarification of rule 28. A catamaran rounding a mark with one hull flying over the mark.
D 4	Q&A 09-034	When one Gate Mark is missing.
D 5	Q&A 10-004	About touching marks and the definitions Finish and Racing.
D 6	Q&A 10-024	The rights of an OCS boat that is sailing the course.

E – Finishing

E 1	Q&A 06-002	When has a boat 'cleared' the finishing line and marks?
E 2	Q&A 06-003	Race committee action when a boat passes the pin end of the finishing line on the wrong side or touches a finishing mark.
E 3	Q&A 07-003	A clarification of fetching at the finishing mark.
E 4	Q&A 08-002	'Normal position' – finishing as a capsized boat.
E 5	Q&A 09-005	Relating to ISAF Case 45 – a case about a sailing instruction that required boats to finish contrary to the definition 'Finish'.
E 6	Q&A 09-016	About shortening of course, finishing when the race committee is positioned at the 'wrong' end of the line.
E 7	Q&A 09-026	When does a boat finish – when is the line a finishing line.
E 8	Q&A 09-035	About Case 112 and Q&A 2009-26.

F – Scoring

F 1	Q&A 01-001	A question relating to the time limit of races.
F 2	Q&A 03-002	Scoring boats OCS after the race based on observations by or statements from competitors or other persons outside the race committee.
F 3	Q&A 03-004	Abandoning a race after some of the boats have finished.
F 4	Q&A 07-001	Awarding of average points in multiple races.
F 5	Q&A 08-001	A clarification about numbering of races.
F 6	Q&A 08-003	A discussion about whether a boat that has retired can un-retire.
F 7	Q&A 09-002	A clarification of 'number of boats entered in a series' for the purpose of scoring under Appendix A.
F 8	Q&A 09-006	A clarification of rule 90.3(a): A race cannot be scored when no boats have sailed the course in compliance with rule 28 and finished.
F 9	Q&A 09-013	Scoring series with multiple rankings.
F 10	Q&A 09-031	How may scoring mistakes be corrected after a regatta?
F 11	Q&A 10-023	Resolving ties in series score when redress is involved.

G – Race Management Practices and Policies

G 1	Q&A 09-009	Special sailing instruction to allow shortening races for safety reasons even after some boats have crossed the finishing line.
G 2	Q&A 09-012	When the race committee observes a boat touching a mark.
G 3	Q&A 10-010	Posting OCS lists at the windward mark.
G 4	Q&A 09-015	About abandonment in match racing. Where to draw the line for what would be an improper action by the race committee.
G 5	Q&A 10-015	Changing the meaning of the Race Signals in the sailing instructions.
G 6	Q&A 10-016	When sailing clubs mix responsibilities for club regattas.
G 7	Q&A 10-018	Race committee procedures for sighting the starting line.
G 8	Q&A 10-021	When using VHF to recall boats.

H – International Jury

H 1	Q&A 02-001	Rule N1.1 and International Jury members on signal- and finishing boats.
H 2	Q&A 03-001	A question relating to International Juries and when they are properly constituted.
H 3	Q&A 09-041	A clarification about submitting questions about Jury decisions.

J – Protests, Hearings, Appeals & Procedures

J 1	Q&A 04-008	Signalling a yellow flag penalty after a general recall.
J 2	Q&A 07-006	Notifying boats of a protest by informing the coach, rules advisor or other representative.
J 3	Q&A 09-011	The weighing and credibility of evidence in protest hearings.
J 4	Q&A 09-039	When a protest committee protests a boat under rule 60.3(a)(2).
J 5	Q&A 09-040	About denial of appeal and national prescriptions.
J 6	Q&A 10-003	Compelled to break a rule by an unidentified boat breaking a rule.
J 7	Q&A 10-005	Conditions for a protest committee to reinstate an abandoned race.
J 8	Q&A 10-006	Protest time limit when the race time limit runs out.
J 9	Q&A 10-008	Redress when boats get entangled with marks.

K – Match Race

K 1	Q&A 09-015	About abandonment in match racing. Where to draw the line for what would be an improper action by the race committee.
-----	------------	---

L – Technical

L 1	Q&A 03-007	A question about the legality of disconnecting the headstay while racing.
L 2	Q&A 08-004	A question about the use of the Yngling gybing line.
L 3	Q&A 09-001	A question about boat wax/polish and rule 53.
L 4	Q&A 09-007	A question about hiking devices and rule 49.1.
L 4	Q&A 09-029	A question about rule 53, textured surfaces and wet sanding.

L 6	Q&A 09-037	Questions about rule 42 when rules 49 to 54 do not apply.
L 7	Q&A 09-038	Using a lead trapeze harness strap buckle (that is a dive weight) and rule 43.1(a).
L 8	Q&A 10-002	Life line material and the Racing Rules of Sailing.

M – Terminology

M 1	Q&A 04-006	When is a boat on a beat to windward?
M 2	Q&A 09-003	Questions about the term 'Starting Area'.
M 3	Q&A 09-018	Is a finishing line a 'gate'?
M 4	Q&A 09-019	Questions about the new definition Fetching.
M 5	Q&A 09-032	When is a boat 'sailing on another leg'?
M 6	Q&A 10-019	Changing course and rule 16.
M 7	Q&A 10-022	When touching only the flag on a mark.
M 8	Q&A 10-026	Paddle test and the exceptions in rule 42.
M 9	Q&A 10-027	Proper Course and sail configuration.

N – Prescriptions and other rules

N 1	Q&A 10-007	National prescriptions not complying with rule 86.1(a).
N 2	Q&A 10-014	Approval for appointment of protest committees.

Deleted Q&As

All published answers are based upon the Racing Rules of Sailing for 2009-2012 and updated in accordance with urgent changes to the Racing Rules of Sailing on January 1, 2010.



ISAF Racing Rules Question and Answer Service

Section A

Fair Sailing

- A1** Slowing another boat's progress in a race.
- A2** A discussion about different aspects of a situation when a boat learns, in an invalid hearing, that she has broken a rule.
-

Other Questions that may be relevant:

D6, F6, L7, M9

ISAF Racing Rules Question and Answer Service



A 001

Q&A 2007-008

Revised: 12 January 2009

Question 1

Is it a violation of Rule 2 if a competitor attempts to slow another boat's progress in a race by covering or limiting its freedom to start, tack or jibe if this behaviour is not aimed at staying ahead of this competitor in a race or a series of races, but instead is purely aimed at skewing the competitor's result for the worse.

Answer 1

Yes.

For the purpose of ISAF Case 78, a race or series is restricted to those races governed by a notice of race as published by the organizing authority for the race under consideration.

Question 2

If the answer to the above question is negative (no violation of rule 2), does that mean that any motivation, may it be fear, hate, anger, greed or revenge (to name but a few) are considered to be within "recognized principles of sportsmanship"? In other words: could one team sail down another team for fun or for revenge at any regatta, as often as it likes?

Answer 2

Not applicable.

ISAF Racing Rules Question and Answer Service



A 002

Q&A 2009-023

Published: 10 March 2009

Question:

At a hearing of an invalid protest, a competitor realizes that he has broken a rule. Is the competitor required by rule 2 to retire (retired after finishing)?

If the competitor doesn't (at his own initiative) retire: is the reluctance to retire a new breach (of rule 2), in a new incident, that can be protested by the protest committee?

Is it recommended that the protest committee protests the competitor (under rule 2) for not retiring?

Can the protestor (of the original invalid protest) protest the protestee for not retiring?

For example:

At a coastal race for X99 class boats (length: 10 meter / 33 feet), boat A and B were at the last mark at the same time. Boat A rounded the lighthouse, while boat B rounded the spar buoy 50 meters (150 feet) further away.

Boat B never hailed "protest", never showed a red flag, and did not inform A in any way that he intended to protest.

B lodged a written protest.

A learnt from the hearing schedule notice on the notice board that he was being protested. During the hearing the protest committee found that the protest by B was invalid. During the hearing A realized that he had misunderstood the course description in the sailing instructions, and that A had indeed sailed the wrong course.

Is A required to retire?

Will it be a breach of rule 2 not to retire?

If so, can this breach of rule 2 be protested by the protest committee?

Is it recommended that the protest committee protests A for breaking rule 2?

Answer:

Two fundamental precepts of sailing are sportsmanship and self-enforcement of the rules. Competitors rely upon each other to follow and enforce the rules, and to promptly take a penalty, which may be to retire when a competitor knows he/she has broken a rule.

When a protest is found to be invalid under rule 63.5, that closes the hearing and the incident unless the finding of invalidity is appealed or the protest committee decides to reopen the hearing under rule 66. No other actions can be taken by the protest committee or any party. Reluctance to retire shall be seen as the same incident, and cannot be protested separately and subsequently by a party, since it presupposes a conclusion that can only follow from the facts found in a valid protest concerning the incident. The protest committee cannot lodge its own protest under rule 2 against the competitor, since it learned of the incident in an invalid protest

Rule 60.3(a) allows a protest committee to protest for what it learns from a report from the representative of the boat, but not for what it learns from an invalid protest.

If the protest committee believe a competitor may have deliberately broken a rule, or has chosen not to retire or take a penalty despite knowing that he/she has broken a rule, the protest committee should speak with the competitor.

If after that discussion the competitor declines to take a penalty despite knowing that he/she has broken a rule, the protest committee should consider acting under rule 69.

If, on the other hand, the protest committee believes the competitor may have deliberately broken a rule, the protest committee should act under rule 69.



ISAF Racing Rules Question and Answer Service

Section B Boat vs Boat

- B1** A collision between two catamarans on opposite tacks at a narrow gate
 - B2** 'Keeping Clear' in a windward /leeward situation
 - B3** When Mark-Room includes room to tack
 - B4** Rights and obligations at obstructions
 - B5** How much room is mark-room?
 - B8** Questions about the windward mark and proper course
 - B7** Obligations when a boat hails for room to tack.
 - B8** A clarification about rule 18.3
 - B9** How early must a boat start taking action to avoid a collision?
 - B10** When does rule 18.3 stop applying?
 - B11** 3 boats overlapped on port tack approaching an obstruction; a racing boat on starboard tack.
 - B12** Finishing mark and rules 18.2 and 18.5
 - B13** Overlap changing from leeward to windward overlap
 - B14** Rule 18.3 and 'causing a boat to sail above close-hauled'
 - B15** Rules 19 and 20 when multiple boats meet.
 - B16** Windward boat must always keep clear.
 - B 17** Two boats tacking in the zone when another is fetching.
 - B 18** Clarifications about Mark-Room and rule 18.3.
-

**Other Questions that may be relevant:
A1, C2, D2, D6, J6, M5, M6, M9**

ISAF Racing Rules Question and Answer Service



B 001

Q&A 2006-005

Revised: 12 January 2009

Situation

Two catamarans on opposite tacks both sailing a downwind leg on reaching angles were approaching the gate heading for different marks. They reached the gate at the same time and collided in the middle. At that moment the gate was less than 6 hull lengths wide and the boats were in both circles at the same time.

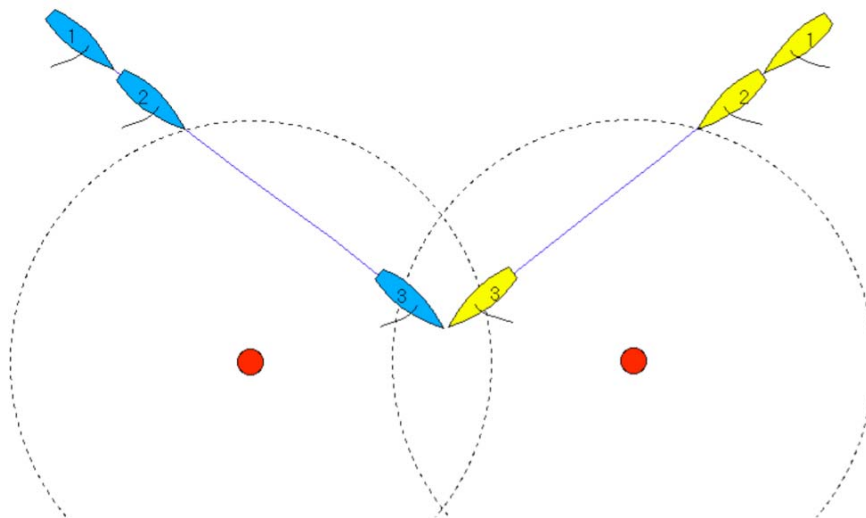

Question 1

What rules do apply and how to decide?

Answer 1

Boats that are sailing to different gate marks are not leaving the same mark on the same side. However, whether or not rule 18 applies, rules 10 and 14 continue to apply. Blue must keep clear of Yellow, and both boats must avoid contact.

Question 2

Could a gate which is less than 6 hull lengths wide be considered as an improper action of the Race Officer?

Answer 2

The width of a gate does not necessarily constitute an "improper" race committee action. Factors such as the size of the fleet, type of boats, wind conditions, sea state, current and water depth must be considered. A "perfectly set" gate may become less-than desirable due to changing conditions, often too late to make any corrections. Even if there was an "improper" action by the race committee in this case, that action did not significantly worsen the boat's score through no fault of her own. The race committee's actions did not prevent the boat from avoiding the collision.

ISAF Racing Rules Question and Answer Service



B 002

Q&A 2009-004

Published: 09 January 2009

Question 1:

W gets increasingly closer to L. They are overlapped on the same tack. There is no contact. L protests under rule 11. In deciding whether W has kept clear, how is the protest committee to decide whether contact after a hypothetical course change by L is 'immediate'? A very gentle change of course might not result in contact for several seconds. A substantial movement of the helm might result in contact in less than a second.

Answer 1:

The protest committee should consider facts, such as distance between the boats, wind and sea conditions and the manoeuvrability of the boats, to decide if W kept clear. The shorter the time between L's change of course and contact, or the risk thereof, the more likely W did not keep clear at the time of L's change of course.

Question 2:

W gets increasingly closer to L. They are overlapped on the same tack. L changes course, and there is contact. L protests under rule 11, and W protests under rule 16.1. The protest committee decides that the contact was immediate. What is the decision?

Answer 2:

When there was (immediate) contact W failed to *keep clear* as per the definition. The decision will be to disqualify W for breaking rule 11.

When L changed course, she had an obligation under rule 16.1 to give W *room to keep clear*. If W had *room* to increase the separation between the boats, but made no attempt to do so, then L had complied with rule 16.1.

ISAF Racing Rules Question and Answer Service



B 003

Q&A 2009-017

Published: 27 January 2009

Situation

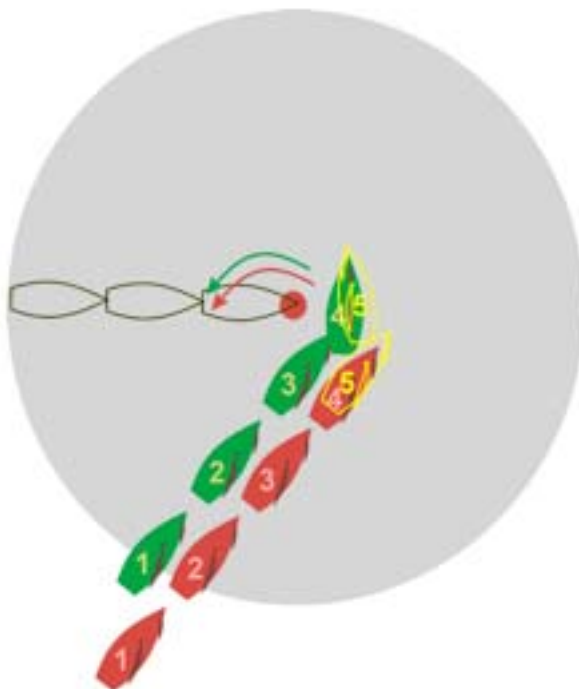

Two port-tack-boats are overlapped approaching the windward mark that should be rounded on port. The windward and inside boat (Green) is tacking to round the mark on her proper course. After Green passes head to wind (position 5), there is a minor contact between Green and Red.

The following comments have been made by the questioner leading to his questions below:

Up to position 4, Red has to give mark-room because of rule 18.2(a).

Mark-room includes the room to tack for the inside windward overlapped boat (see definition Mark-Room). After passing head to wind, the boats are not overlapped and rule 18.2(a) ceases to apply and rule 18.2(b) ceases to apply (See last sentence of rule 18.2(c)).

Question 1:

Does the outside boat (Red) break rule 18.2(a)?

Answer 1:

No.

It is clear from the diagram that when the first boat (Green) reaches the zone, she is either overlapped inside Red or she is clear ahead of Red. In either case, rule 18.2(b) applies and requires Red to give Green mark-room. Red breaks rule 18.2(b) at position 4, while the boats are on the same tack.

Question 2:

Is the breach of rule 13 by the inside boat (Green) exonerated by rule 18.5(a) or 18.5(b)?

Answer 2:

Green is exonerated under rule 18.5(b). Her breach of rule 13 (a rule of section A) while rounding the mark on her proper course results from Red's failure to give her mark-room while rule 18 applied.

ISAF Racing Rules Question and Answer Service



B 004

Q&A 2009-021

Published: 16 February 2009

Background:

Two boats, Blue and White, are racing. They are approaching a big obstruction that can be passed on either side. The courses steered by both boats are towards the middle of the obstruction. At position 1 Blue is clear ahead (by a very narrow margin) and on a track to windward of White. When Blue bears away slightly, she immediately becomes overlapped to windward of White.

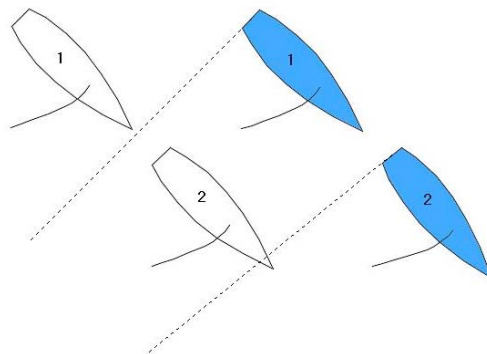

Rule 19.2(a) states that the right-of-way boat may choose to pass the obstruction on either side. In position 1 Blue is clear ahead, and thus has right-of-way under rule 12. When Blue bears away and becomes overlapped to windward of White, White becomes the right-of-way boat under rule 11.

Question:

How can we determine which boat has the right to choose the side for passing the obstruction?

Answer:

At any point in time the right-of-way boat at that moment is entitled by rule 19.2(a) to choose on which side she will pass the obstruction. Therefore, when the boats are at position 1, Blue has the right to choose to pass the obstruction on either side. However, when the boats reach position 2 Blue has lost that right, and at that time White has the right to choose.

When a right-of-way boat acts to implement a choice she has made under rule 19.2(a), she must comply with any applicable rules of Sections A and B. In addition, rule 19.2(b) applies if the boats are overlapped. In that case, the outside boat must give the inside boat room between her and the obstruction, unless she has been unable to do so from the time the overlap began.

In the case shown in the diagram, if after position 2 White chose to leave the obstruction to starboard and if the boats remained overlapped, White would have to comply with rules 16.1 and 17, and Blue would have to give White room between her and the obstruction as required by rule 19.2(b).

ISAF Racing Rules Question and Answer Service



B 005

Q&A 2009-022

Published: 23 February 2009

Definitions

Mark-Room Room for a boat to sail to the *mark*, and then *room* to sail her *proper course* while at the *mark*. However, *mark-room* does not include *room* to tack unless the boat is *overlapped* to *windward* and on the inside of the boat required to give *mark-room*.

Proper Course A course a boat would sail to *finish* as soon as possible in the absence of the other boats referred to in the rule using the term. A boat has no *proper course* before her starting signal.

Question 1

Is a boat entitled to mark-room allowed to make a tactical approach/tactical rounding (often called "wide in, tight out") of the mark or is boat entitled to mark-room only allowed to a seamanlike approach/rounding?

Answer 1

Mark-room is split into two aspects:

- (i) Room to sail to the mark. If the boat entitled to mark-room is the keep-clear boat, then room to sail to the mark is neither room to sail her proper course (if extra room is needed for a proper course approach), nor is it room to make a more tactical rounding. If the boat entitled to mark-room has right of way, she is free to sail any course within the limitations of the rules of Part 2, Section B, and, if it applies, rule 18.4.
- (ii) Then, room to sail her proper course while at the mark. A boat may sail her proper course from the time she is at the mark and while she rounds or passes the mark and until she no longer needs the mark-room. This course would therefore be the one the boat would sail in the absence of the other boats referred to in the rule.

Only an inside right-of-way boat that is entitled to mark-room may make a tactical approach and a tactical rounding. However, if the inside right-of-way boat is subject to rule 18.4, then, until she gybes, she may not sail farther from the mark than needed to sail her proper course. Note that a tactical rounding may be wider than a proper course rounding.

Question 2

Before the 2009 rules there was a difference in rounding a mark when the inside boat also had right of way and was specifically permitted to make a tactical rounding unlike a situation with an inside keep-clear boat where a tactical rounding was not permitted.

Is that situation continued under the 2009 rules?

Answer 2

There is no game change between the 2005 and 2009 rules for the purpose of room given or taken at a mark. The removal of the preamble to Section C in the 2005 rules that said 'To the extent that a Section C rule conflicts with a rule in Section A or B, the Section C rule takes precedence' means that there is now no precedence to any of the rules of Sections A or B, so those rules always apply whenever a boat is entitled to mark-room. As a result, the words 'and if the inside boat has right of way the outside boat shall also keep clear' are no longer necessary.

ISAF Racing Rules Question and Answer Service



B 006

Q&A 2009-025

Revised: 28 December 2009

Two situations for clarifying the question of proper course in relation to the new definition Mark-Room and rule 18.5(b).

Situation 1

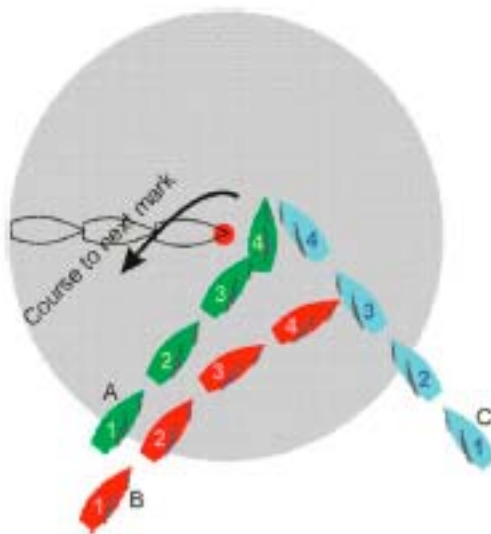

A (Green) on port windward is overlapped at the zone to B (Red) and therefore entitled to mark-room (rule 18.2(b)). C (Blue) on starboard is fetching the mark. B passes astern of C. A is rounding the mark as she would do in the absence of the boats B and C. A does not keep clear of C.

Question 1:

Is A sailing her proper course?

Answer 1:

The proper course of A is not relevant in this situation as no part of rule 18 applies between A and C (rule 18.1(a) and (b)).
A must keep clear of C under rule 10.

Question 2:

What should the decision be?

Answer 2:

A did not to keep clear of C as required by rule 10. Disqualify A.
B gave A mark-room and did not compel A to break rule 10, so rule 64.1(c) is not applicable.

Situation 2

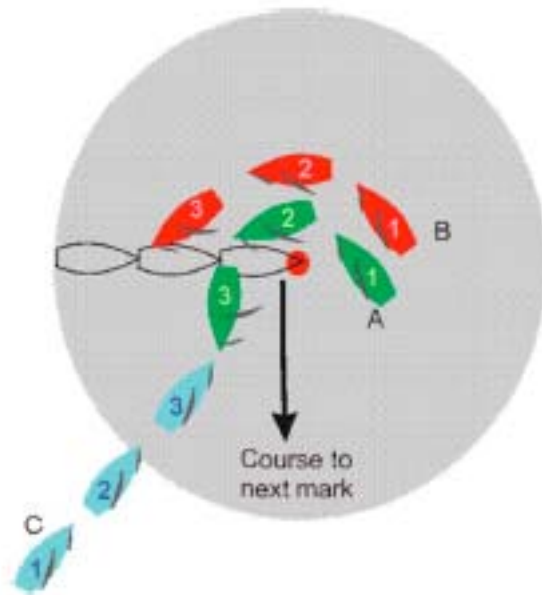

A (Green) on starboard tack leeward is overlapped to B (Red) at the zone on a windward mark to be left on port. C (Blue) is approaching the mark on port tack. A is rounding the mark as she would do in the absence of the boats B and C. By changing her course at the mark to a downwind course A comes to a collision course with C, without giving C room to keep clear.

Question 1:

Is A sailing her proper course?

Answer 1:

The proper course of A is not relevant in this situation as no part of rule 18 applies between A and C (rule 18.1(c)).

Question 2:

What should the decision be?

Answer 2:

A is a right-of-way boat on starboard and C is keep-clear boat on port. When A changes course, she is required by rule 16.1 to give C room to keep clear, which she has not done.

Disqualify A for breaking rule 16.1.

B has given A the mark-room to which she was entitled and B did not compel A to break a rule, so rule 64.1(c) is not applicable.

ISAF Racing Rules Question and Answer Service



B 007

Q&A 2009-028

Revised: 28 December 2009

Two questions regarding rule 20.1:

Question 1:

Rule 20.1(b) requires a boat hailed for room to tack to respond by 'tacking as soon as possible, or by immediately hailing 'You tack'.

Does a hailed boat have to respond to a hail to comply with her obligations under rule 20.1 in the following situations?

- (a) When a boat hails for room to tack when approaching a starting mark surrounded by navigable water or its anchor line from the time boats are approaching them to start until they have passed them?
- (b) When the hailing boat is clearly below a close-hauled course?
- (c) When the hailing boat on starboard tack is approaching a port tack boat and hails for room to tack for that port tack boat?
- (d) When the hailing boat calls for water to tack?
- (e) When the hailing boat will not have to make a substantial course change to avoid the obstruction?
- (f) When the obstruction is a mark that the hailed boat is fetching?

Answer 1:

- (a) No. The preamble to Section C of Part 2 makes it clear that none of the Section C rules, including rule 20, apply in that situation.
- (b) No. The scenario in which rule 20.1 applies is when 'a boat sailing close-hauled or above hails for room to tack'. If the hail comes from a boat in any other circumstance, rule 20.1 does not apply.
- (c) No. Rule 20.1 applies only when a boat sailing close-hauled or above approaches an obstruction. A port-tack boat is not an obstruction to starboard-tack boats unless they are required to keep clear of her or, if rule 22 applies, avoid her.

However, a boat that hails for room to tack in the knowledge that rule 20 does not apply may break rule 2.

- (d) Yes. There are no words described in the rule that have to be used, so a hail of 'water' or 'room' to tack would both clearly communicate the intention of the hailing boat.

- (e) Yes. The boat that hails breaks rule 20.3 by hailing when safety does not require her to make a substantial course change to avoid the obstruction. However, the hailed boat must still comply with rule 20.1(b).
- (f) Yes. The boat that hails breaks rule 20.3 by hailing when the obstruction is a mark that the hailed boat is fetching. However, the hailed boat must still comply with rule 20.1(b).

Question 2:

Does the hailing boat comply with her obligation to tack by going through head to wind or does she have to reach a close-hauled course?

Answer 2:

The hailing boat must tack and reach a close-hauled course on the new tack.

ISAF Racing Rules Question and Answer Service



B 008

Q&A 2009-030

Published: 27 April 2009

Two boats were approaching a mark on opposite tacks and one of them changed tack outside the zone. When the boat that changed tack entered the zone she was past head to wind but had not yet reached a close hauled course.

The other boat was fetching the mark.

Question:

Does rule 18.3 now apply between the two boats?

Answer:

Yes.

The requirements for rule 18.3 to apply are met when, as a result of changing tack, one of them is subject to rule 13 in the zone and the other is fetching the mark.

Whether the boat changes tack outside or inside the zone is irrelevant.

ISAF Racing Rules Question and Answer Service



B 009

Q&A 2009-033

Published: 08 July 2009

Situation:

The boats are Extreme 40 catamarans.

Yellow is sailing downwind on starboard; Blue is sailing upwind on a different leg on starboard, overlapped to leeward of Yellow.

Yellow sails over the top of Blue. Blue holds her course throughout. There is contact between the bow of Blue and the aft port quarter of Yellow (last 15cm or so). Yellow tries to avoid the contact 'at the last minute' by bearing away.

The diagram refers.

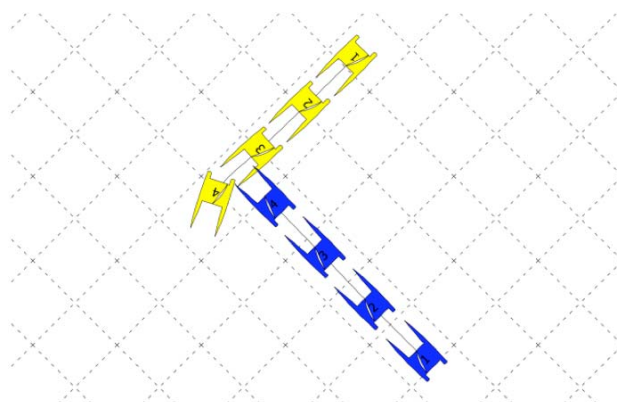

Question

Under rule 14, Yellow must avoid contact if it is reasonably possible to do so.

Does the fact that Yellow had the option to bear away or luff before reaching Blue mean she has had reasonable possibilities to avoid contact?

Or need Yellow only take action to avoid contact when it is clear to her that a collision course has been established between her and Blue and she must do something to avoid contact (i.e. here when she is crossing and realises she is not going to keep clear without further action?).

Answer

Rule 14 requires all boats to avoid contact if reasonably possible. When a keep-clear boat approaches a right-of-way boat on a converging course it is in all but the most extraordinary cases reasonably possible to avoid contact. In addition, when a keep-clear boat sails a course to pass directly in front of a right-of-way boat, it is always reasonably possible to avoid contact if appropriate action to keep clear is taken early enough.

In addition, in a situation as described, when the right-of-way boat realises that the keep-clear boat is not going to keep clear, she too has an obligation under rule 14 to try and avoid contact.

In this case, it was reasonably possible for Yellow, as the keep-clear boat, to have avoided contact by luffing or bearing away before she reached Blue. It was also reasonably possible for Blue to have avoided contact when it became clear to her that Yellow was not keeping clear. This she failed to do. 'However, Blue, as the right-of-way boat, could only be penalised under this rule if the contact caused injury or damage to either boat.'

ISAF Racing Rules Question and Answer Service



B 010

Q&A 2009-036

Published: 9 September 2009

Question

At a windward mark to be left to starboard, Blue is fetching the mark and Yellow tacks in the zone as shown in the diagram. Up to position 2 Yellow breaks no rule and will not do so if she continues to bear away to sail to the next mark. However, Yellow luffs and Blue must sail above close-hauled to continue keeping clear. She does so and protests. Does Yellow break a rule?

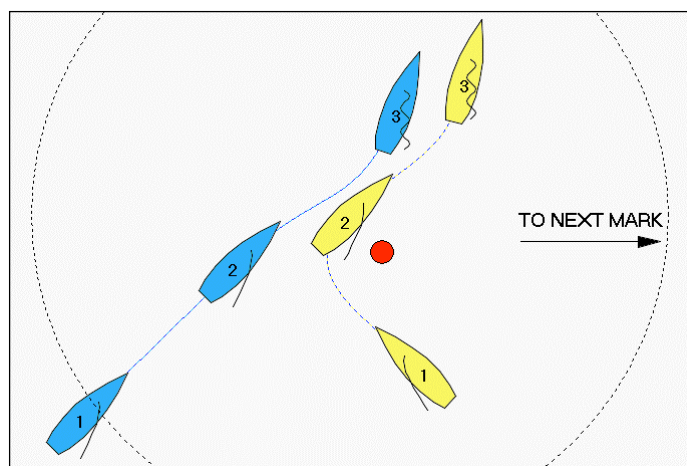

Answer

Yellow and Blue were approaching the mark on opposite tacks. When Yellow changed tack and as a result was subject to rule 13 in the zone when Blue was fetching the mark, rule 18.3 applied. When rule 18.3 applies, rule 18.2 does not thereafter apply. Blue keeps clear as required by rule 11 and Yellow's luff complies with rule 16. Yellow causes Blue to sail above close-hauled to avoid her. If either boat is still in the zone, rule 18 continues to apply - see the first sentence of rule 18.1 - and therefore Yellow breaks rule 18.3(a).

This answer will also apply to a 'mirror-image' situation at a port-hand windward mark.

ISAF Racing Rules Question and Answer Service



B 011

Q&A 2010-001

Published: 14 January 2010 (amended 15 January 2010)

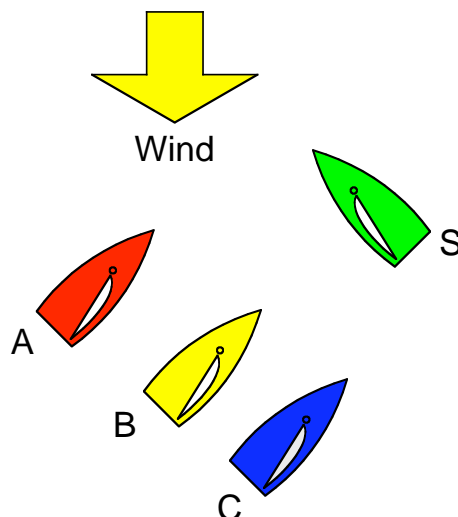

Assumed facts:

Boats A, B and C are close-hauled on port tack, A being to windward of B who is to windward of C.

Boat S is close-hauled on starboard tack with a risk of collision with A. If B and C did not change course, both would pass astern of S.

Boat A bears away to duck S, and B bears away to give her space to pass astern of S. C holds her course and there is a collision between B and C, which results in neither damage nor injury.

Neither boat takes a penalty. There is a protest between B and C.

Question:

How do the rules apply to this incident and which boat or boats should be disqualified?

Answer:

A, B and C are required to keep clear of S. S is therefore an obstruction to all three. Because C has right of way over both B and A, C may elect which side of S to pass (see rule 19.2(a)). However, because C does not need to change course to avoid S, C may not call for room to tack under rule 20. As C passes astern of S she is required by rule 19.2(b) to give room to both B and A to pass between her and S. Similarly, B is also required by rule 19.2(b) to give A room.

The room that C is required to give to B includes enough space for B to give A room and for B to keep clear of C (see the principle highlighted in italics in Team Racing Call E9). C does not give that room and, therefore, breaks rule 19.2(b), and so C should be disqualified. C also breaks rule 14 as, had she given that room, the contact could have been avoided. However, because there was no damage or injury, C can not be penalized under rule 14.

B breaks rule 11, but she is exonerated under rule 64.1(c) because she was compelled to do so by C's breach of rule 19.2(b).

ISAF Racing Rules Question and Answer Service



B 012

Q&A 2010-009

Published: 15 February 2010

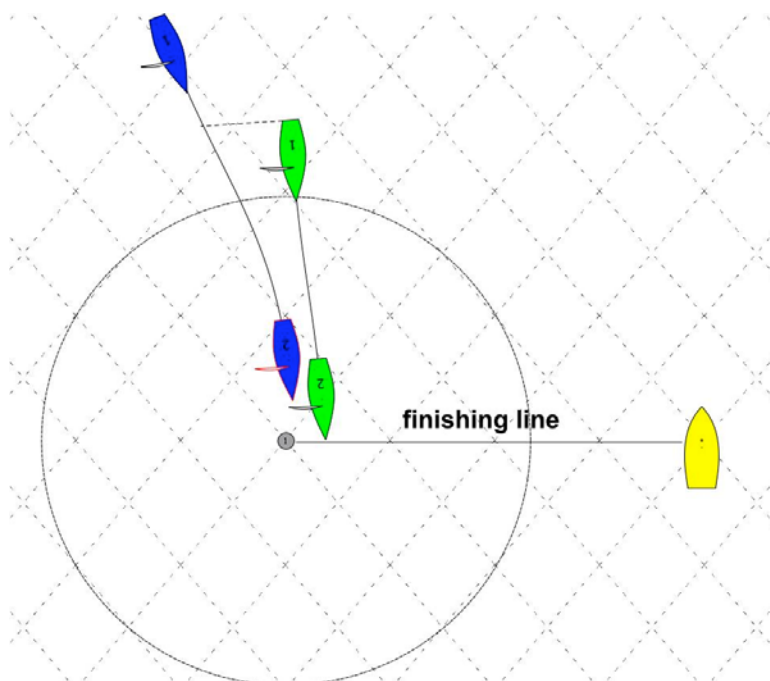

Situation:

Green and Blue on port tack are approaching the starboard end of a downwind finishing line. Green is clear ahead of Blue at the zone. Green sails directly to the finishing mark. Blue establishes a leeward overlap without breaking rule 15. Blue then has to change course to avoid Green.

Question 1:

Does Blue break rule 18.2(b)?

Answer 1:

No. Green has chosen to cross the finishing line close to the mark. Green is entitled to mark-room, which means room to sail to the mark. Blue gives mark-room by changing course to avoid Green.

Question 2:

Will Green be exonerated under rule 18.5(a) for her breach of rule 11?

Answer 2:

Yes.

Question 3:

Would the answers be different if there was contact that both boats could have avoided?

Answer 3:

Unless there was contact with damage or injury, neither boat would be penalized for the breach of rule 14, because Blue was right-of-way boat and Green was entitled to mark-room. However, if Blue did not change course and there was contact, she would have broken the second sentence of rule 18.2(b) by not giving Green mark-room.

ISAF Racing Rules Question and Answer Service



B 013

Q&A 2010-011

Published: 9 March 2010

Situation:

Two boats are on converging courses. Boat S has a fixed bowsprit.

In position 1 S is overlapped to leeward of A and has been for some time.

In position 2 the bowsprit overhangs the stern of A.

In position 3 S is to windward of A.

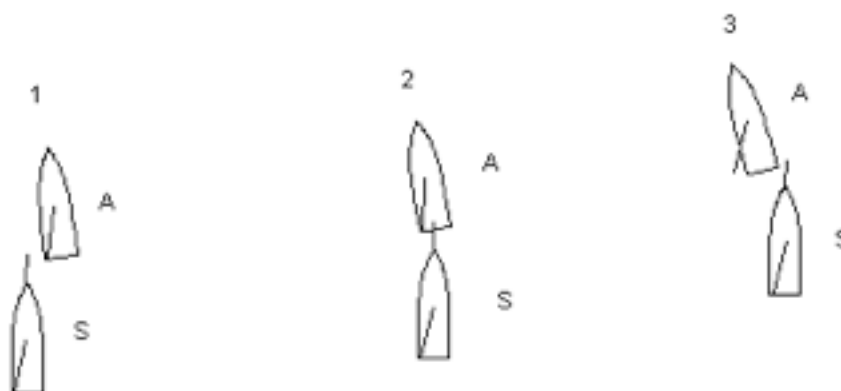

Question 1:

When does the transition of S from being the leeward boat to being the windward occur? Is it when

- 1 S ceases to be completely on the leeward side of A,
- 2 the bowsprit passes the centre line of A, or
- 3 S is completely to windward of A?

Answer 1:

While not a racing rule, the 'last point of certainty' principle may assist protest committees in finding the facts in order to apply the rules. In this case, S would cease to be leeward boat when there is certainty that the relative positions have changed. Given the limited facts in this case, it is position 3 when it is certain S is to windward of A.

Question 2:

At what point would S be held to be in breach of a rule if there was contact between the boats during the overlap?

Answer 2:

S would be breaking rule 14 if there was contact between the boats. However, while S was right-of-way boat, she could only be penalized for breaking rule 14 if there was damage or injury. Once S becomes keep-clear boat she is required to keep clear of A.

The Racing Rules of Sailing have been written on the basis of avoiding contact and keeping boats clear of each other. Provided S did not break rule 15, 16 or 17 while she was right-of-way boat, it is A that is breaking rule 11, be there contact or not. When someone is looking down from above, at

the moment just before he would see the bowsprit over any part of the deck of the windward boat or boat ahead, a rule may have been broken because the right-of-way boat at that moment often 'needs to take avoiding action' (see definition Keep Clear). While this concept of 'looking down from above' is not a rule, it may assist protest committees in finding the facts in order to apply the rules.

Question 3:

Would the answers change if originally S had been to windward and ended up to leeward?

Answer 3:

The principles for deciding the situation would be the same, but the rules application would differ.

Question 4:

If there is a point where neither boat is the leeward boat, and neither boat is clear astern, which boat is obliged to keep clear?

Answer 4:

While not a racing rule, the 'last point of certainty' principle may assist protest committees in finding the facts in order to apply the rules. In this case, until there is certainty that right of way has changed, it must be assumed that it has not.

Question 5:

If the overlap has been established from clear astern, and assuming that A had been given room to keep clear, what relative positions of the boats would have to exist in order for S to be the leeward boat?

Answer 5:

S is the leeward boat when she becomes overlapped to leeward – see definition Overlap. While not a racing rule, the 'last point of certainty' principle may assist protest committees in finding the facts in order to apply the rules. In this case, S remains leeward boat until there is certainty that she is no longer overlapped or to leeward.

Note:

When a protest committee finds that a keep-clear boat did not alter course to avoid a collision, and that there was not a genuine and reasonable apprehension of collision on the part of the right-of-way boat, it should dismiss her protest. When the committee finds that the right-of-way boat did change course, and that there was reasonable doubt that the keep-clear boat could have kept clear, the keep-clear boat should be disqualified. (ISAF Case 50 refers).

If reasonably possible, contact shall be avoided by both boats as required by rule 14.

ISAF Racing Rules Question and Answer Service



B 014

Q&A 2010-12

Published: 10 March 2010

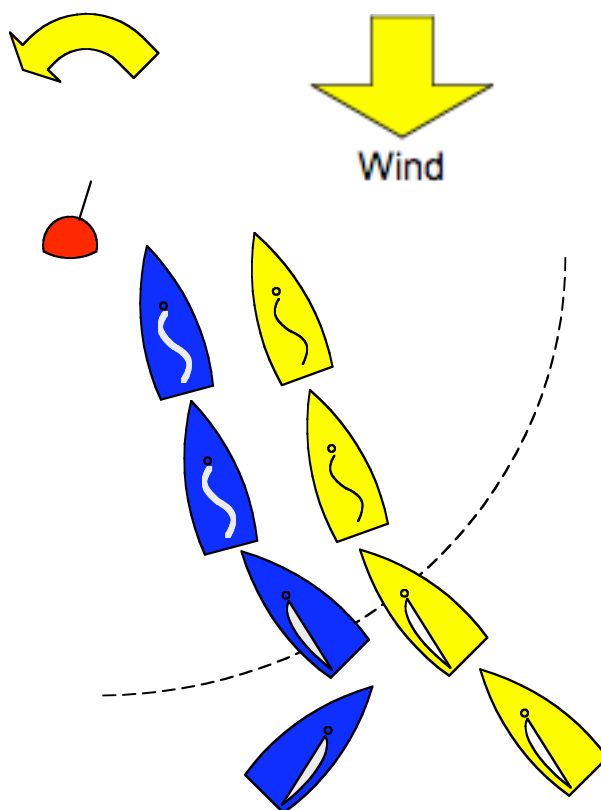

Situation:

Yellow and Blue are heavy boats that can keep way on in the conditions.

Yellow is fetching the mark but, had Blue not been there, she could not pass it without sailing above close-hauled.

Blue is subject to rule 13 in the zone, reaches a close-hauled course and then luffs to pass the mark. Yellow is able to keep clear.

Question:

Does Blue break rule 18.3?

Answer:

Yes.

When Blue luffs, Yellow cannot avoid Blue without sailing above close-hauled. Blue has therefore caused Yellow to sail above close-hauled. The fact that Yellow would not pass the mark without sailing above close-hauled is irrelevant.

ISAF Racing Rules Question and Answer Service



B 015

Q&A 2010-13

Published: 30 March 2010

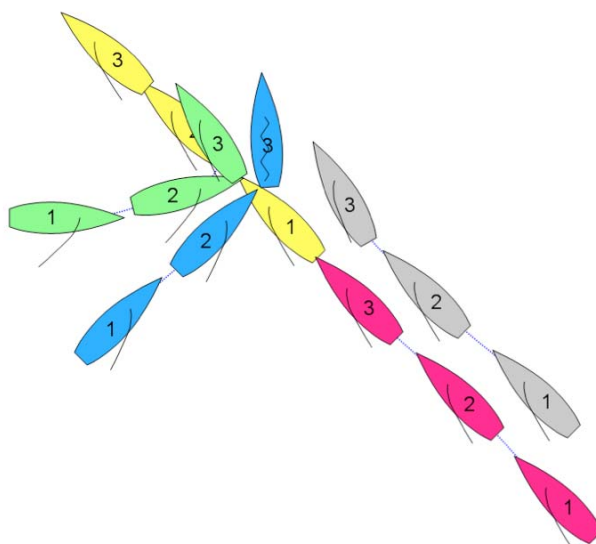

Situation at position 1

Green is an inside boat and will require room from Blue to pass behind Yellow. The leeward port boat Blue is sailing a course to pass behind the leading starboard boat Yellow.

Blue is able to cross the leeward starboard boat Purple easily, but will have to make a substantial alteration of course to avoid the windward starboard boat Grey. Blue asks Green for room to tack.

Question 1

When Blue asks for room to tack at position 1 does that relieve her of her obligations under rule 19.2 (b) to give Green room to pass below the leading starboard tack boat?

Answer 1

No. Although the preamble to Section C says that when rule 20 applies rule 19 does not, that is the case only between two boats at the same obstruction. Rule 19.2(b) requires Blue to give room to Green at the obstruction Yellow.

Separately, rule 20 applies between Blue and Green at Grey, which is a different obstruction. Both rules therefore apply.

Question 2

If the answer to Q1 is no and Green passes behind Yellow and tacks as soon as possible, will Blue be exonerated under rule 20.2 if while tacking she fails to keep clear of Grey?

Answer 2

No. Rule 20.2 says that it applies when a boat is taking room to which she is entitled under rule 20.1(b). Because the room referred to in rule 20.2 is room for a boat responding to a 'You tack' reply, Blue cannot be exonerated under 20.2 with respect to Grey.

Question 3

If the answer to Question 2 is also no, and Blue cannot tack after position 2 and keep clear of Grey or bear away and keep clear of Purple, what should she do?

Answer 3

Blue must hail Green in time to give Green time to respond as required by rule 20.1(a). If after Blue's hail, Green was able to tack to leeward of Yellow, Green broke rule 20.1(b) by not doing so. If that resulted in Blue breaking rule 10 or 13 with respect to Grey, Blue would be exonerated in any resulting protest hearing under rule 64.1(c).

If after Blue's hail the first opportunity for Green to tack was after passing astern of Yellow, Green complied with rule 20.1(b). Blue must avoid contact with other boats if reasonably possible and take a penalty if she believes she may have broken a rule of part 2.

ISAF Racing Rules Question and Answer Service



B 016

Q&A 2010-17

Published: 21 May 2010

Situation:

Two boats on opposite tacks approach the weather mark, to be rounded to port. A is on port-tack and B is on starboard-tack. A tacks onto starboard inside the zone and becomes overlapped inside of B, who doesn't alter her course. A couple seconds after A has completed her tack, B bears away to round the mark and in doing so has contact with A.

Question:

Which rules are broken?

Answer:

When the windward boat B bears away and touches the leeward boat - the windward boat breaks rules 11 and 14.

ISAF Racing Rules Question and Answer Service



B 017

Q&A 2010-020

Published: 5 June 2010

Situation:

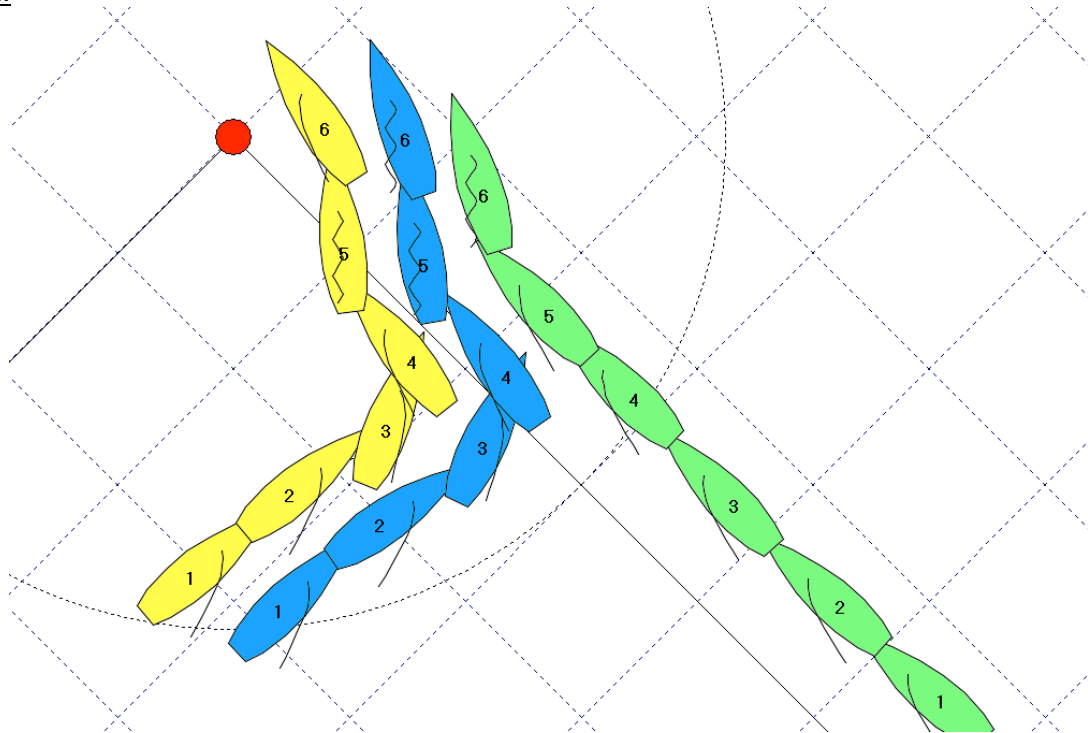

Shortly after position 2, Yellow decides she can tack and fetch the mark. Blue initially believes she can cross in front of Green so she does not hail for room to tack. However, as soon as Yellow luffs to tack, Blue immediately luffs and tacks so that the two boats tack simultaneously. Upon completion of their tacks, there is room for one boat (not both) to pass between Green and the mark.

After the tack is completed Yellow luffs to round the mark and Blue luffs to give Yellow mark-room. Green has to luff above close-hauled to avoid Blue. Green protests Blue and Blue protests Yellow.

Question 1:

What should the decision be?

Answer 1:

Penalize Blue for breaking rule 18.3(a).

Green was required to keep clear of Blue from the moment Blue completed her tack. Green kept clear, and broke no rule.

Yellow was required by rule 18.3(a) not to cause Green to sail above close-hauled to avoid her. When Green sailed above close-hauled, it was to avoid Blue, not to avoid Yellow. Yellow did not break rule 18.3(a).

Blue was required to keep clear of Yellow once Yellow completed her tack. Blue kept clear and did not break rule 11.

In addition Blue was required by rule 18.3(a) not to cause Green to sail above close-hauled to avoid her. Blue broke that rule. Blue cannot be exonerated under rule 64.1(c), because she was neither compelled to break a rule, nor did Yellow break any rule.

Question 2:

Would the answer to Question 1 be different if there is not even room for one boat to pass between Green and the mark when the two boats complete their tacks?

Answer 2:

No. If after the tack Yellow is able to luff and fetch the mark and Blue is able to luff and keep clear of Yellow, and Green, although sailing a course to pass close to the mark, is able to luff and keep clear of Blue, the answer will be the same.

In either case, if Blue were not there, Yellow would break rule 18.3(a) if she caused Green to sail above close-hauled to avoid her.

ISAF Racing Rules Question and Answer Service



B 018

Q&A 2010-25

Published: 29 June 2010

Situation

Two Farr 45's are approaching a windward mark in flat seas, wind force three, at approximately 7 – 7.5 knots

Blue is fetching the mark on starboard tack.

Yellow, approaching on port tack, tacks onto starboard tack within the zone and comes onto a close-hauled course on the layline to the mark. Yellow's tack causes her to slow down and Blue is forced to bear away below Yellow to avoid contact. Blue is then unable to lay the mark directly.

Blue luffs above close-hauled to round the mark. In doing so she slows down.

Yellow responds to the luff and bears away onto the new course keeping clear of Blue.

Blue is able to round the mark and bears away onto the new course.

There was no contact between Blue and Yellow.

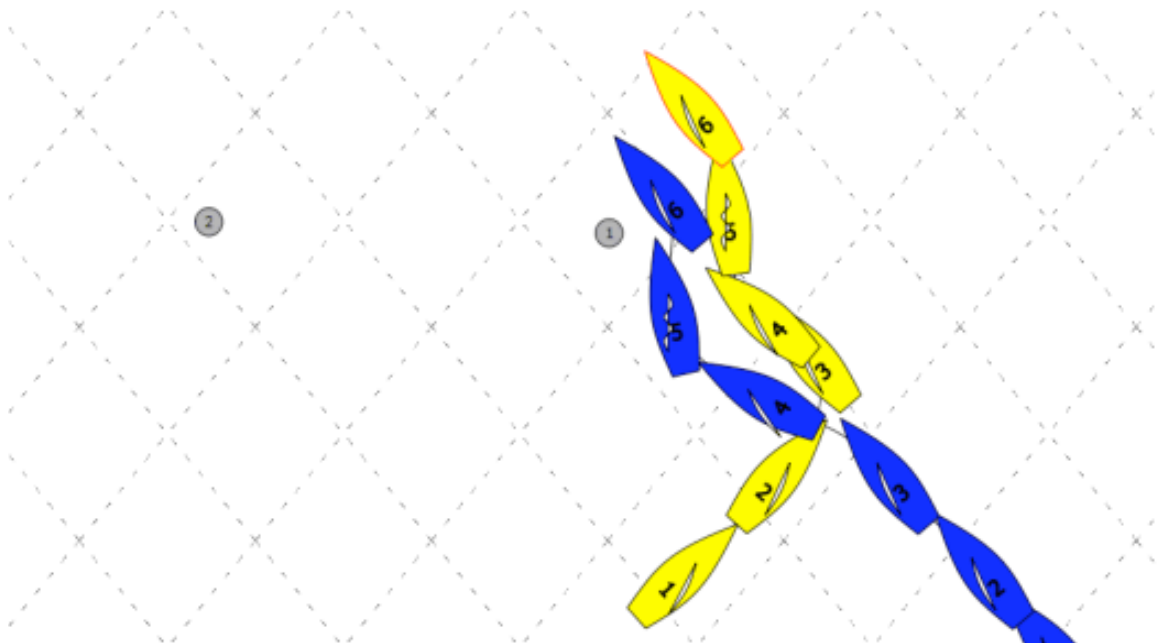

Question 1

Does rule 18.2(a) apply from the time Blue establishes the overlap?

Answer 1

No. Rule 18.3 applies. When rule 18.3 applies, rule 18.2 does not thereafter apply. See rule 18.3.

Question 2

Rule 18.3(b) requires Yellow to give Blue mark-room when Blue becomes overlapped inside her. Did Yellow give Blue room to sail to the mark as defined in Mark-Room?

Answer 2

Yes. Once Blue became overlapped inside Yellow, Yellow must give Blue room to sail to the mark. Blue needed to sail above a close-hauled course to sail to the mark and Yellow gave Blue the room needed.

Question 3

If the answer is no, is this a breach of rule 18.3?

Answer 3

Not applicable.

Question 4

Can a case be made that Blue could not sail her proper course when at the mark because of the actions of Yellow, and that she therefore was unable to finish 'as soon as possible'?

Answer 4

No. Blue became right-of-way boat the moment the overlap was established. Yellow was required to keep clear of Blue, and to give room for Blue to sail to the mark, and then room to sail her proper course while at the mark. Yellow kept clear of Blue and gave Blue room to bear away to sail her proper course at the mark. The fact that Blue had to sail below her proper course to keep clear of Yellow before the overlap was established is not relevant.

Question 5

Would it then be the case that Blue was prevented from sailing her proper course while at the mark?

Answer 5

Not applicable.

Question 6

Is the effect of questions 4 and 5 above that there is a breach of rule 18.3?

Answer 6

No.

Question 7

Was Blue 'at the mark'

- a. when she was obliged to bear away at position 3?
- b. when her bow was close to the mark at position 5?

Answer 7

A boat will normally be 'at the mark' when she is close to it and her next action will be to change course to round it. This will then be her proper course. In this case, that would happen at position 5.



ISAF Racing Rules Question and Answer Service

Section C

Starting

C1 A clarification about rule 30.1, I Flag Rule (Called Round-an-End Rule)

C2 When boats start in both directions – what should be done?

Other Questions that may be relevant:

D2, D6, F2, G3, G7, G8, J1, M2

ISAF Racing Rules Question and Answer Service



C 001

Q&A 2007-004

Revised: 12 January 2009

Situation

Rule 30.1 (Round-an-End Rule) applies. 50 seconds before the start, a boat is on the course side of the line. She then sails as shown on the diagram and crosses the extension of the starting line from the course side to the pre-start side (between situations 3 and 4).

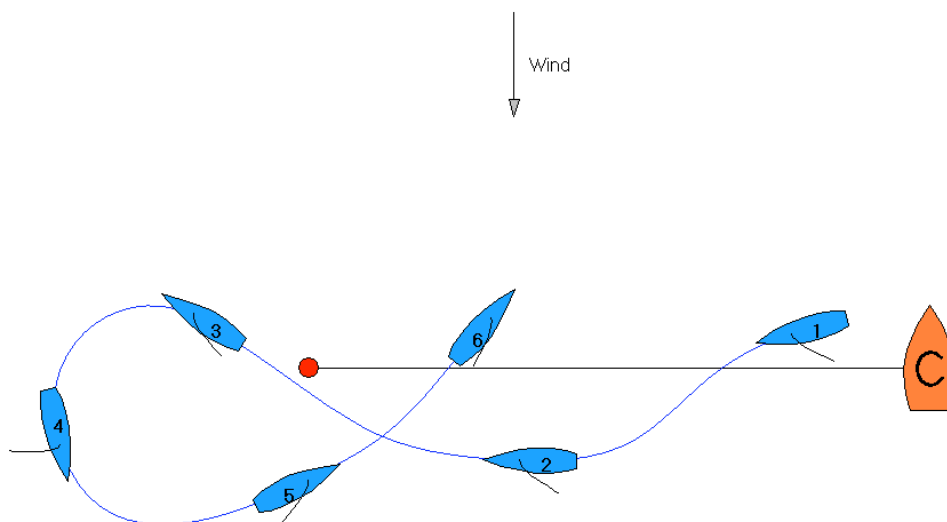

Question

Has the boat complied with the requirements of rule 30.1?

Answer

Yes. Rule 30.1 requires that the boat cross an extension of the starting line from the course side to the start side before she starts, and she meets this requirement.

ISAF Racing Rules Question and Answer Service



C 002

Q&A 2009-027

Published: 22 April 2009

Situation:

This incident occurred at the start of a handicap cruiser race. Race duration expected to be from 4-8 hours depending on boat type, and in wind conditions of around 7 knots.

The sailing instructions defined the location of the starting line, and that it would be delineated by a committee boat and by a navigation mark. They did not specify whether the committee boat was at the starboard end of the line, or in any other way define in which direction the boats should start. The starting line was laid approximately perpendicular to the wind direction. The first mark was to leeward of the line, on a heading which was at an angle of approximately 30 degrees from the line itself.

Some boats started in each direction, there was evidence that the Race Committee had attempted to give verbal instruction to some boats shortly before the start to resolve the mess they saw developing. Those which started to windward rounded the Race Committee boat as soon as possible, and bore away to the mark. They were disadvantaged by taking the initial tack away from the mark.

Shortly after the start, there was a collision between boat A that was starting on starboard to windward, and boat B on port, which was intending to start to leeward and was crossing the line in the opposite direction. The starboard boat had cleared her starting line before the collision.

Question 1:

Can a race be started from a line that does not have a defined starting direction?

Answer 1:

The starting line must be described in the sailing instructions. The definition Start defines the direction from the pre-start side to the course side without any requirement that it be further described in the sailing instructions.

Question 2:

If the answer to Question 1 is yes, would a Protest Committee be correct in abandoning the race if it determined that some boats were significantly disadvantaged through their choice of starting direction?

Answer 2:

Once a protest committee has decided that a boat is entitled to redress it is required to 'make as fair an arrangement as possible for all boats affected,' For a boat to be eligible for redress, the worsening of her score must have been through no fault of her own. By starting contrary to the definition Start, a boat will fail that test. However, if it was not reasonably possible for the competitors to clearly identify which way they were expected to cross the starting line in order to

comply with the definition, one option available to a protest committee under these circumstances would be to let the results of the race stand. ISAF Case 82 describes a similar situation at a finishing line,

Question 3:

If the Protest Committee was correct in abandoning the race, were the boats no longer subject to the Racing Rules of Sailing at the time of the collision?

Answer 3:

The boats were racing and were subject to the Racing Rules of Sailing. That is not affected by any later decision of a protest committee to grant redress by abandoning the race. The effect of the abandonment is that penalization for breaking a rule of Part 2 is not possible - see rule 36.

ISAF Racing Rules Question and Answer Service



Section D

Sailing the Course

- D1** 'Side of a mark' for the purpose of rule 28.
 - D2** A boat forced to the wrong side of a mark still needs to sail correctly around that mark. She is not 'compelled' to break rule 28.
 - D3** A clarification of rule 28. A catamaran rounding a mark with one hull flying over the mark.
 - D4** When one Gate Mark is missing.
 - D5** About touching marks and the definitions Finish and Racing
 - D6** The rights of an OCS boat that is sailing the course.
-

Other Questions that may be relevant:

C2, E2, E4, E5, E6, E7, F2, F3, F6, F8, G1, G8, J8, M3, M5

ISAF Racing Rules Question and Answer Service



D 001

Q&A 2009-008

Published: 09 January 2009

Question

For the purpose of rule 28, Sailing the Course, how should one understand 'side of a mark'?

Answer

For the purpose of rule 28, the required side of the mark is where the string representing the boat's track will be when the boat has sailed the course described in the sailing instructions. This applies even if the string is also looping a mark.

See also ISAF Cases 90, 106 and 108.

ISAF Racing Rules Question and Answer Service



D 002

Q&A 2009-010

Published: 09 January 2009

Situation

In order to avoid contact with another boat or a mark, Yellow is forced to the wrong side of the mark when Blue fails to give her room to round or pass it. Yellow then continues on the next leg without returning and passing the mark on its required side.

Question

Can the protest committee conclude that this was a consequence of Blue breaking the rule requiring her to give room to Yellow, and exonerate Yellow under rule 64.1(c) for her breach of rule 28.1?

Answer

No.

A boat cannot be exonerated under rule 64.1(c) unless she was compelled to break the rule as a consequence of another boat breaking a rule. In this case, although Blue broke a rule when she did not give Yellow room at the mark, she did not compel Yellow to break any rule. Yellow could have passed the mark on its required side any time after the incident. Yellow did not break rule 28.1 until she finished.'



ISAF Racing Rules Question and Answer Service

D 003

Q&A 2009-014

Published: 09 January 2009

Question

A catamaran on port tack approaches a leeward mark to be left to port. Does a catamaran that "flies" its port (windward) hull over, and possibly to windward of, a leeward mark comply with the requirements of rule 28.1 in relation to that mark rounding? The starboard hull is the only hull in the water (creating a track) and this hull passes the mark correctly.

Answer

Yes.

ISAF Racing Rules Question and Answer Service



D 004

Q&A 2009-034

Published: 17 August 2009

Situation:

The following sailing instructions apply:

SI 8.1

The diagram in attachment A shows the courses, including the approximate angles between legs, the order in which marks are going to be passed, and the side on which each mark is going to be left. (Start at leeward between the RC and the pin end mark, windward to be left to port, gate mark as leeward mark and finish at windward between the RC and windward mark).

SI 9

Mark 1 (windward) and Mark 2 (pin end mark) will be yellow pyramidal buoys; gate marks (leeward gate) 3p & 3s will be small red pyramidal marks.

Incident:

On the first downwind leg with several boats approaching the gate, one of the marks blows up and sinks because of the intense heat. The race committee did not replace the mark or substitute it with an object flying flag M as provided for in rule 34.

Question 1

On which side of the only remaining mark should the boats pass? (Rule 28.1 (c))

Answer 1

In the absence of any relevant sailing instruction, the remaining buoy is no longer a mark. When the sailing instructions describe a gate, the boats are required to pass between the gate marks in order to comply with rule 28.1(c). When one of two gate marks disappears, the other no longer has a required side. Boats may leave the buoy on either side and may even touch it.

To avoid this problem, race committees are recommended to specify a required side when only one buoy of a gate is present, so that there will still be a mark with a required side. Boats would then round the remaining mark as any other single rounding mark, and they would also not be allowed to touch it.

When there is no such sailing instruction, then it is proper for the race committee to consider abandonment under rule 32.1(d). However, if it does not do so, and if all boats choose to leave the remaining buoy either to port or to starboard (or a mixture thereof) without incident and they then sail the rest of the course, post race redress could be considered at the instigation of the race committee, the protest committee, or by a request by a boat.

If one or more boats decided to sail a shorter course than others, such as not rounding the remaining buoy, or were otherwise disadvantaged by, for example, searching for the missing buoy, that would constitute grounds for abandonment. Otherwise, if the protest committee is satisfied after taking appropriate evidence that all boats have had a fair race, and no boat was prejudiced by

the race committee's actions, it would be appropriate to decide that the fairest arrangement as possible was to let the results stand.

The requirement that at least one boat must sail the course in order for a race to be scored, assumes that it is possible for at least one boat to do so. That is not the case here, and a protest committee is entitled to ignore that in these circumstances.

Question 2

If the answer is any side, is it correct that rule 18 does not apply any more and the rules of Part 2 Section A apply if there are boats leaving the mark to port and to starboard at the same time?

Answer 2

If boats choose to round the remaining buoy, the rules of Part 2 Section A will apply between them, both when boats leave it on the same side and when it is left on different sides. The rules of Part 2 Section B will equally apply.

It should be noted that the rules of Part 2, Section A and B also apply when the rules of Section C (including rule 18) apply. When rule 18 applies, a boat entitled to mark-room will in some circumstances be exonerated for breaking some of those rules. Since the remaining buoy is no longer a mark, rule 18 (including rule 18.5) does not apply.

ISAF Racing Rules Question and Answer Service



D 005

Q&A 2010-004

Published: 20 January 2010

Situation

The definition of racing says 'A boat is *racing* from her preparatory signal until she *finishes* and clears the finishing line and *marks* or retires, etc'

Rule 31 says, 'While *racing*, a boat shall not touch a starting *mark* before *starting*. A *mark* that begins, bounds or ends the leg of the course on which she is sailing, or a finishing *mark* after *finishing*.'

Question:

If she finishes under the definition of racing, that is, she has finished, and cleared the line, and then touches the mark, does she break rule 31?

Answer:

No. Rule 31 does not apply because if a boat has finished and cleared the finishing line and marks, the boat is no longer racing.

See also Q&A 2006-002

ISAF Racing Rules Question and Answer Service



D 006

Q&A 2010-24

Published: 29 June 2010

Situation

A fleet race starts and on the first run there is a luffing match between L and W. Both boats protest, and there is contact with no damage or injury. After the race it is discovered that W was OCS.

Question

Is it open to W to allege that she and L were not on the same leg, and that when L initiated a luffing match L was not only sailing above her proper course, she was also breaking rule 23.2 because she was interfering with W?

Answer

Both L and W are on the same leg. While W may not have started correctly, and may subsequently be scored OCS, she continues to sail the race with full rights and obligations under the rules.

Nothing in the rules would prevent W from making any allegation against L, but the protest committee would be bound by the rules and as both boats are on the same leg, rule 23.2 does not apply.

ISAF Racing Rules Question and Answer Service



Section E

Finishing

- E1** When has a boat 'cleared' the finishing line and marks?
 - E2** Race committee action when a boat passes the pin end of the finishing line on the wrong side or touches a finishing mark.
 - E3** A clarification of fetching at the finishing mark.
 - E4'** Normal position' – finishing as a capsized boat.
 - E5** Relating to ISAF Case 45 – a case about a sailing instruction that required boats to finish contrary to the definition 'Finish'.
 - E6** About shortening of course, finishing when the race committee is positioned at the 'wrong' end of the line.
 - E7** When does a boat finish – when is the line a finishing line.
 - E8** About Case 112 and Q&A 2009-26.
-

Other Questions that may be relevant:

B12, D5, F1, F3, F11, G1, J8, M3

ISAF Racing Rules Question and Answer Service



E 001

Q&A 2006-002

Revised: 12 January 2009

Question

With respect to the definition *Racing*, when has a boat 'cleared' the finishing line and marks?

Answer

A boat clears the finishing line and marks when no part of her hull, crew or equipment is on the line and when neither mark is influencing her course.

A boat that clears the finishing line close-hauled and continues to sail toward the finishing line pin end mark, where current sets her into the mark, is still racing and has broken 31. A boat that crosses the finishing line, sails away from the line and marks, and then later hits the finishing line mark, does not break rule 31 as she is no longer racing.

ISAF Racing Rules Question and Answer Service



E 002

Q&A 2006-003

Revised: 12 January 2009

Situation A

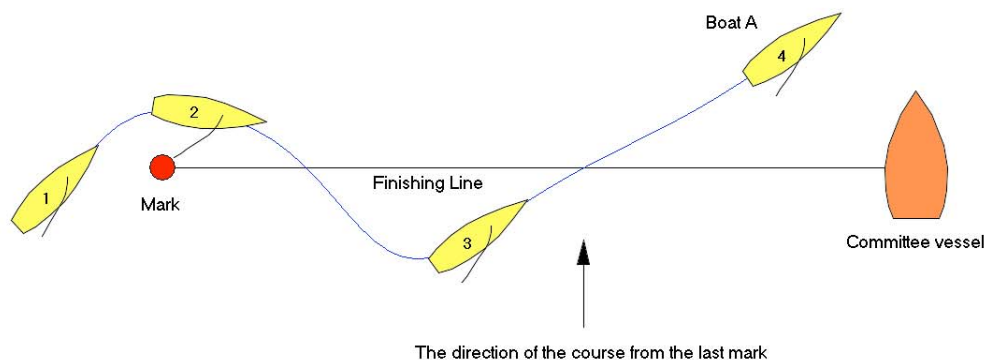

Question 1

In situation A, the race committee observes Boat A passing the pin end of the finishing line on the wrong side and then dipping below the line, finishing, and sailing into the harbour. What should the race committee do in this situation?

Answer 1

The race committee must score the boat in her finishing place because she complied with the definition Finish. The race committee should protest Boat A for breaking rule 28. After crossing the finishing line, a boat may correct an error in sailing the course made at the finishing line, but if she does not, she must be scored as finished when she first crossed.

Question 2

Does the race committee need to remain on station until after the race time limit in case Boat A returns to correct her error?

Answer 2

No, unless it is likely that Boat A will return to correct her error and finish within the time limit.

Situation B

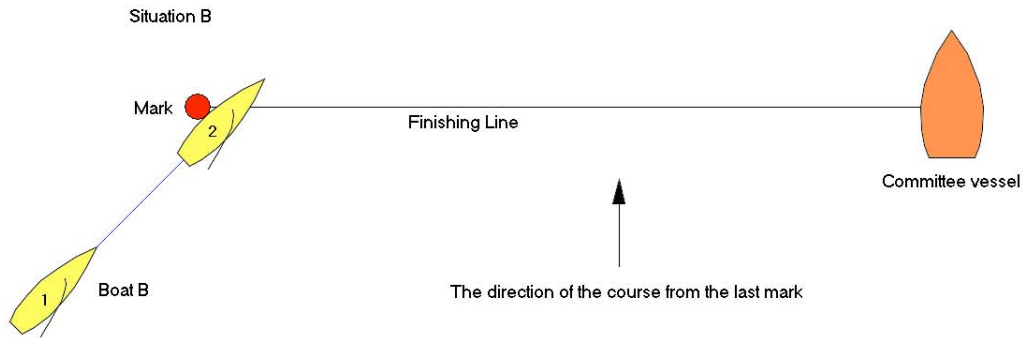

Question 3

In Situation B, the race committee observes Boat B breaking rule 31 as she crosses the finishing line. Boat B does not take a penalty and sails home. What should the race committee do?

Answer 3

The race committee must score Boat B in her finishing place when she first crossed the finishing line. See the definition Finish. The race committee may protest the boat for breaking rule 31. See rule 60.3.

ISAF Racing Rules Question and Answer Service



E 003

Q&A 2007-003

Revised: 12 January 2009

Situation

PW and PL approach the committee boat that is also a finishing mark. PW can fetch the finish, but she can't fetch the bow of the race committee boat. PL hails to PW for room to tack. PW replies: "I can fetch the finish! "

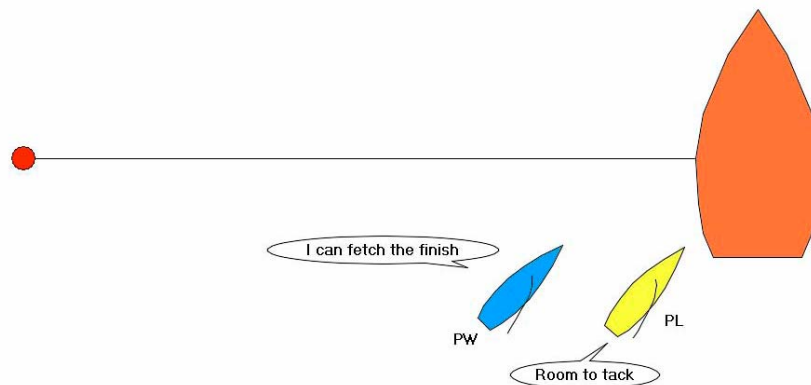

Question 1

For the purpose of rule 20.3, when shall PL not hail for room to tack?

- (a) When PW is fetching the finishing line (but not the race committee boat); or
- (b) When PW can fetch the race committee boat.

Answer 1

- (b) PL shall not hail when PW can fetch the race committee boat.

The Mark in this question is a race committee boat from which the finishing line extends.

Question 2

Did rule 20.1 apply?

Answer 2

Yes.

ISAF Racing Rules Question and Answer Service



E 004

Q&A 2008-002

Revised: 12 January 2009

Question 1

With respect to the definition Finish, does the condition "in normal position" refer also to the hull?

Answer 1

No, the normal position refers to crew or equipment only. The commas before and after "or crew or equipment in normal position" limit the normal-position requirement only to the crew and equipment.

Question 2

With respect to the definition Finish, the Terminology paragraph of the Introduction and the second part of rule 47.2, does a capsized boat correctly finish if she crosses the finishing line when:

- a) all of the crew members are (somehow) on board even though the boat is capsized,
- b) some of the crew members are not on board but are very close to the boat and trying to straighten it out , and
- c) some of the crew members are not on board because they have become disconnected from the boat and its equipment, but are swimming to reach the capsized boat?

Answer 2

Yes. It is normal for dinghies to capsize and therefore a capsized dinghy and its crew in the water are in a normal position. It follows that a boat finishes correctly in all of the conditions stated in the question.

Also, the boat does not break rule 47.2 while the crew are making all reasonable attempts to recover the boat and get back on board provided they are not making any attempt to progress the position of the boat in the race. If they attempt to 'swim' the boat across the finishing line, they would break both rule 47.2 and rule 42.1, and possibly rule 2.

ISAF Racing Rules Question and Answer Service



E 005

Q&A 2009-005

Published: 09 January 2009

Question 1

Based on the facts described in Case 45, would the decision of the protest committee be different, if X had lodged -parallel to its request for redress- a valid protest against Y and all other "hook-finishing" boats for breaking rule 28.1, with special regard to the "string rule" and the word "finish" in the first sentence of the rule?

Answer 1

The protest committee could have disqualified all boats that complied with the invalid sailing instruction, and then initiated redress for them based on their score being made significantly worse by the improper action of the race committee in altering a definition in the sailing instructions. Complying with the invalid sailing instruction led them to break rule 28.1 by failing to finish in accordance with the definition, and their action was therefore through no fault of their own.

Question 2

Would it be correct to say that Y and all "hook-finishing" boats cannot be exonerated for breaking rule 28.1, because they were not compelled by another boat to break the rule, as required by rule 64.1(b)?

Answer 2

Yes, the boats cannot be exonerated. However, they can be given redress as they were misled by the improper action of the race committee.

Question 3

If the protest committee decided that all the mentioned boats should to be disqualified for breaking rule 28.1, could they have requested redress under rule 62.1, or would it be their own fault as they should have known that the SI was invalid because it changed the definition "finish"?

Answer 3

The boats could have requested redress - see answer to Q1 above.

ISAF Racing Rules Question and Answer Service



E 006

Q&A 2009-016

Published: 21 January 2009

Situation

According to the Sailing Instructions marks were to be left to port. Due to insufficient wind the race committee shortened the course by displaying flag S with two sounds at a staff on a committee boat near the windward mark.

Due to bad anchoring conditions at the starboard side of the mark the committee anchored the boat at the port side of the windward mark and so laid the finishing line at the "wrong side" of the mark.

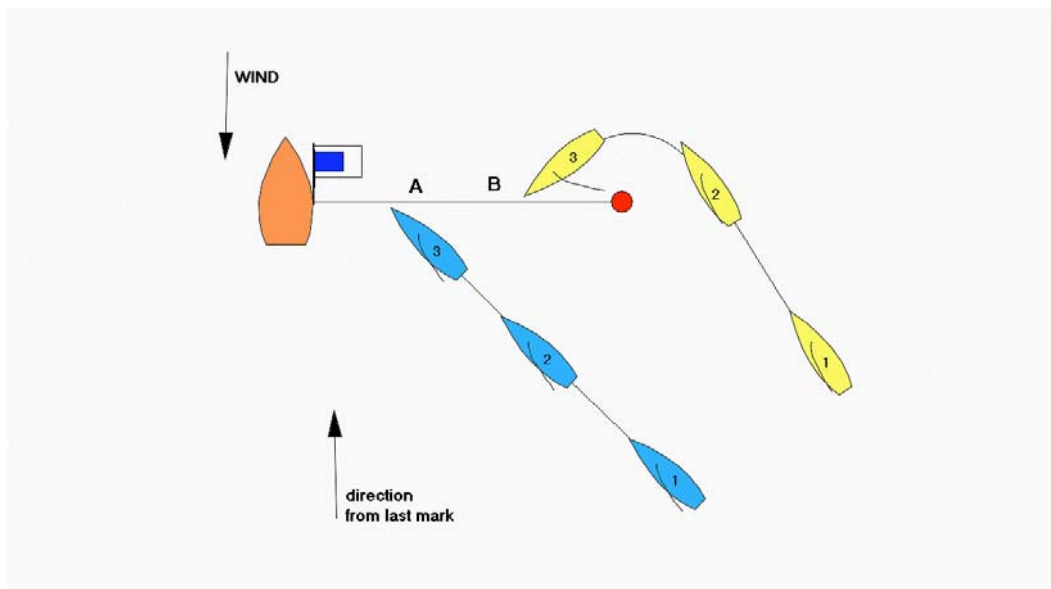

Question 1

Are boats after the race committee has shortened the course still required to leave the mark to port and make a hook round finish as boat B (yellow) in the diagram, or is this mark no longer a rounding mark but a finishing mark so that boats are required to cross the finishing line in the direction of the course from the last mark as boat A (blue) in the diagram?

Answer 1

Because the race committee has signaled a shortened course, the mark is now a finishing mark rather than a rounding mark, and boats must cross the finishing line in the direction of the course from the last mark in accordance with the definition Finish. In the diagram, boat A finishes correctly.

Question 2

Could the protest committee consider laying the finishing line at the “wrong side” of the mark an improper action of the race committee, refer to case 45 *Revised 2007* and decide to score all the boats in the order they crossed the finishing line without regard to the direction in which they crossed it?

Answer 2

No. As long as the line clearly is at an angle to the course from the last mark, the definition Finish gives the correct finishing direction, irrespective of which side the finishing vessel is situated.

Had the race committee issued a sailing instruction that required the boats to cross the finishing line from the wrong direction, that would have been an improper action, and redress could have been considered (see ISAF Case 45).

ISAF Racing Rules Question and Answer Service



E 007

Q&A 2009-026

Published: 15 April 2009

The course is three laps windward/leeward course, with a finishing line to windward of the windward mark.

Boat X completes only two laps and then sails to the finishing line and crosses it from the direction of the leeward mark.

Question 1

Does she finish according to the definition?

Answer 1

No.

The sailing instructions describe the course with the finishing line being at the end of the last leg of the course (the end of lap 3). The finishing marks therefore only have a required side at that time and at no earlier point in time.

Rule 28.1(a) says that a boat shall pass each mark on the required side. As the finishing marks only have a required side when a boat is on the last leg of the course described in the sailing instructions, a boat does not finish according to the definition if it passes between these marks on an earlier leg of the course.

Question 2

Having crossed the finishing line, may she return to complete the last lap?

Answer 2

Yes.

Rule 28.1 allows a boat to correct any errors to comply with that rule. There is no time limit specified in that rule as to when the correction is to be completed. However, the boat would need to finish within any time limit specified in the sailing instructions.

Question 3

In terms of rule 28.1, at what point does she break the rule?

Answer 3

As indicated in Case 112, she does not break rule 28.1 until she finishes. In this situation, she has not finished until she has corrected her error in not sailing the last lap of the course.

Question 4

If she doesn't break rule 28.1 until she finishes, what meaning has the phrase 'She may correct any errors to comply with this rule'?

Answer 4

It means that she may correct any errors to comply with rule 28.1 until she finishes (see answer 2 above). Any error made at the finishing line, even after finishing, is covered by the last words of the definition Finish – 'after correcting an error made at the finishing line, under rule 28.1.'

Boat Y seeing that X was making her way to the finishing line before completing the course, was close enough to hail 'protest' but waited till X crossed the finishing line before informing her of her intention to protest.

Question 5

Does this hail satisfy the requirement of rule 61.1?

Answer 5

Yes.

See answer 3 in Case 112. However, see also the answer to question 1. Boat X would not have crossed the actual finishing line at this time and therefore would not have finished and she still had the opportunity to sail the course in accordance with rule 28.1.

Question 6

Could informing X before she crossed the finishing line constitute a breach of rule 41 by X?

Answer 6

No.

The hail of protest by boat Y was unsolicited advice for boat X. However, as the finishing line for X is still one lap away, she still has the opportunity of correcting her error as provided by rule 28.1, provided she can finish within any time limit specified in the sailing instructions.

ISAF Racing Rules Question and Answer Service



E 008

Q&A 2009-035

Published: 26 August 2009

Question

Can you please clarify how Case 112 and Q&A 2009-26 are consistent with regard to the requirement to sail the course in order to finish?

Answer

The definition Finish states three circumstances under which a boat crossing a finishing line has finished. ISAF Case 112 Q&A 2 addresses only one of them, namely a boat that crosses a finishing line after sailing the full course length intended by the race committee, but without having corrected an error at an earlier mark, and does not correct that error. By not correcting her error she has broken rule 28.1, which is a separate issue but she has finished, for the first (and only) time.

Q&A 2 of Q&A 2009-26 addresses the third way to finish, namely after correcting an error such as may have happened in ISAF Case 112. The correction will annul the previous Finish and the boat has now both finished and complied with rule 28.1.

Q&A 1 of Q&A 2009-26 clarifies Q&A 2 of ISAF Case 112 in saying that sailing the full course length intended by the race committee but having left a mark on the wrong side, as in ISAF Case 112, is a different issue from crossing a finishing line having not yet sailed the full course length, which ISAF Case 112 does not address.

Discussions arising from Case 112 and Q&A 2009-26 suggest that these distinctions are not clear from the rules themselves, and that these distinctions raise important policy issues. The chairman of the Racing Rules Committee has appointed a small working party to address these issues

In the interim, the ISAF Regulation 31.3 says in part that 'The cases are authoritative interpretations of the rules for all racing' Regulation 31.3.8 says that 'Answers to questions provided by the Racing Rules Question and Answer Panel published on the ISAF website are not authoritative interpretations and explanations of the Racing Rules. However, they are carefully considered opinions of an experienced panel whose members have a thorough knowledge of the Racing Rules and extensive experience as competitors or as race officials.'

ISAF Racing Rules Question and Answer Service



Section F

Scoring

- F1** A question relating to the time limit of races.
 - F2** Scoring boats OCS after the race based on observations by or statements from competitors or other persons outside the race committee.
 - F3** Abandoning a race after some of the boats have finished.
 - F4** Awarding of average points in multiple races.
 - F5** A clarification about numbering of races.
 - F6** A discussion about whether a boat that has retired can un-retire.
 - F7** A clarification of 'number of boats entered in a series' for the purpose of scoring under Appendix A.
 - F8** A clarification of rule 90.3(a): A race cannot be scored when no boats have sailed the course in compliance with rule 28 and finished.
 - F9** Scoring series with multiple rankings.
 - F10** How may scoring mistakes be corrected after a regatta?
 - F 11** Resolving ties in series score when redress is involved.
-

Other Questions that may be relevant:

D5, E2, E7, G3

ISAF Racing Rules Question and Answer Service



F 001

Q&A 2001-001

Revised: 12 January 2009

Situation

A race has a time limit of two hours for the first boat to finish. The first boat finishes at 1 hour 59 minutes.

Questions

Does she finish within the time limit of rule 35 if:

1. She was scored OCS and did not return?
2. She started correctly and was later disqualified for breaking a rule?
3. She was recorded as having broken rule 30.3?

Answers

1. No. To comply with rule 35 (Time Limit), a boat must also comply with rule 28.1 (Sailing the Course) which requires her to start correctly.
2. Yes, provided the rule she broke was not rule 28.
3. Yes, provided she started in accordance with the definition Start. However, she will be disqualified in accordance with rule 30.3 and scored BFD.

ISAF Racing Rules Question and Answer Service



F 002

Q&A 2003-002

Revised: 12 January 2009

Situation

At the starting signal, the race committee observes three boats on the course side of the starting line. The race committee identifies Boat A and Boat B by sail number, but cannot identify the third boat. The race committee properly signals individual recall, but only the two identified boats return to start. After the race, Boat A and Boat B protest Boat C for not starting according to the definition and rule 28.1.

Based on the information in the protests, the race committee decides that the protested boat (Boat C) is the boat they could not identify at the start. Before the protests are heard, the race committee scores Boat C OCS without a hearing, in accordance with rule A5

Question 1

Is the race committee allowed to score a boat under rule A5 after the race?

Answer 1

Yes. Under rule A5, the race committee may score a boat, or correct a score, at any time.

Question 2

May a race committee decision to score a boat OCS under rule A5 be based on observations or statements from competitors or other persons outside the race committee?

Answer 2

No rule specifically prohibits the race committee from using other evidence than its own observations when scoring a boat OCS. However, if Boat C requested redress for being scored OCS, the protest committee would decide whether the race committee's procedure for identifying boats was proper.

ISAF Racing Rules Question and Answer Service



F 003

Q&A 2003-004

Revised: 12 January 2009

Situation

After 3 of 22 boats had finished, a race was abandoned because of a sudden thunderstorm that seriously affected the safety of the competitors. There was no opportunity to re-sail the race.

Question 1

Are the requirements of Rule 32.1, especially the last sentence fulfilled?

Answer 1

Yes. The last sentence in rule 32.1 never prevents a race committee from abandoning a race under rule 32.1(b) or 32.1(e) for safety reasons.

Question 2

Would a request for redress meet the criteria of Rule 62.1?

Answer 2

No. In this case, there has been no improper action or omission of the race committee.

ISAF Racing Rules Question and Answer Service



F 004

Q&A 2007-001

Revised: 12 January 2009

Situation

A regatta is held over two days, with five races scheduled and one drop race if five races are completed. On the first day, only Race 1 is completed and Boat A finishes in second place.

On the second day, Boat A finishes fifth in Race 2. Before the start of Race 3, A collides with B and is unable to compete in all the remaining races due to the damage. She protests B and requests redress. The protest committee finds that A is entitled to redress under rule 62.1(b).

The protest committee awards A average points according to A10(b) for races 3 and 4. A scores DNC in Race 5, but discards that score and is placed first in the total score. Therefore, A wins the regatta, having competed in only two out of five races.

Question 1

Did the protest committee make an error?

Answer 1

Yes. Although the protest committee did not break any rule, its decision in awarding the redress was not the fairest arrangement for all boats affected. In this case, allowing a boat to use average scores for half of the counting races in the series is not fair to the other boats.

Question 2

What would have been a more fair redress decision?

Answer 2

The protest committee should ensure that out of the counting races in a boat's series score, the majority of scores are based on finishing positions in completed races. Different situations may require different redress to be granted. One possible suggestion in this particular case is that the protest committee could have awarded redress only for the race where the collision took place.

ISAF Racing Rules Question and Answer Service



F 005

Q&A 2008-001

Revised: 12 January 2009

Question

The Notice of Race states the Racing Schedule as follows:

Day 1 – Race 1 and 2

Day 2 – Race 3 and 4

Day 3 – Race 5 and 6

The weather conditions are not suitable for racing on Day 1. Therefore the first race will be sailed on Day 2.

Will the series start with Race 1 or with Race 3?

Answer

Unless the race committee post a proper notice on the official notice board stating that Races 1 (and 2) are abandoned and will not be re-sailed, or the Sis make some other provision, then the series should continue with Race 1.

It is generally accepted best practice to sail races in the original sequence unless there is a good reason to do otherwise. Typically this will be when different courses, or special races, are specified within the event.

ISAF Racing Rules Question and Answer Service



F 006

Q&A 2008-003

Revised: 12 January 2009

Question

A yacht believes that she had broken a rule and retired after finishing (RAF). Subsequently, she discovers that she had not in fact broken a rule and asked for her retirement to be rescinded.

May the race committee re-score the yacht in her finishing position?

Answer

The Racing Rules of Sailing are silent with regard to the right of a boat to rescind her retirement, if the race committee are compelled to act on such notification and if there is any time limit for such actions.

As the rules do not prohibit such action, a boat may notify the race committee that she rescinds her retirement. The race committee may reinstate the boat and adjust the score of all boats affected by this notification.

In the event that another boat did not lodge or withdrew an otherwise valid protest based on the original retirement of the boat, the protest committee should extend the time limit and hear the protest.

If the boat did not act in good faith, such as, attempting to avoid being protested by first retiring and then rescinding that retirement, she breaks rule 2, Fair Sailing. Her breach may even be a gross breach of sportsmanship and justify a hearing under rule 69.

If the race committee did not reinstate her finishing position and she requests redress, the protest committee should consider if the original retirement was her own fault and if her action to rescind the retirement was timely. Especially if the retirement is rescinded after the end of the protest time limit, they may conclude that the race committee have made no error and they may also find that the score of RAF was not 'through no fault of her own' and refuse the request.

If the race committee do reinstate the boat and other boats in the fleet request redress then any such request should be refused as there is no error by the race committee.

ISAF Racing Rules Question and Answer Service



F 007

Q&A 2009-002

Published: 09 January 2009

In a championship, there were 47 entries received, 44 paid but only 40 boats were present on site, had their equipment inspected and were scored at least once in a race (even if only as DNF...)

In Appendix A, boats are "scored points for the finishing place one more than the number of boats entered in the series".

The organising committee calculated scores based on 44 boats entered, and rejected the request of the class to score based on 40 boats entered. This affects the ranking of several competitors.

Question 1:

Does it comply with Appendix A to score 44 boats when only 40 were on site and passed the equipment control?

Answer 1:

For the purposes of rule A4.2, the number of boats entered in a series is the number of boats that have complied with the eligibility and entry requirements stated in the notice of race. Rule 75 refers. Any boat whose entry has been rejected or cancelled in accordance with rule 76 shall be deducted from this number.

Question 2:

In case of a split into Gold and Silver is it correct to use 44 boats (i.e. 22 in Gold and 22 in Silver)? This would create a Gold Fleet with 22 and a Silver Fleet with 18 boats?

Answer 2:

The Racing Rules of Sailing do not state any requirement for a split of the entries into two or more fleets. There is guidance in the optional appendix LE. Any split is entirely a matter for sailing instructions and should be described in detail there.

ISAF Racing Rules Question and Answer Service



F 008

Q&A 2009-006

Published: 09 January 2009

Situation

In a race all boats sailed the wrong course. Rather than sailing a trapezoid inner course as signalled by the race committee, all boats sailed an outer course. After the finish, the race committee protested the entire fleet. The protest committee found that none of the boats had sailed the course and disqualified all of the boats under rule 28.1.

Question

Should the race have been scored with all boats receiving a DSQ or should it have been abandoned?

Answer

There was a valid protest and the protest committee found as a fact that none of the boats had sailed the course in compliance with rule 28.1. Rule 90.3(a) allows a race to be scored only "... if one boat sails the course in compliance with rule 28.1 and *finishes* within the time limit...".

As rule 90.3(a) prohibits the race from being scored the protest committee must abandon the race instead of disqualifying the boats.

ISAF Racing Rules Question and Answer Service



F 009

Q&A 2009-013

Published: 09 January 2009

Situation

The notice of race specifies that there shall be three rankings for an event: Boy's, Girl's and Team Overall. The Team Overall ranking would be made by adding the final scores of the competitors of each team.

The race committee ranked the teams first, second and third as follows:

		Individual place	Total score
Team A –	Girl A1	1	6
	Girl A2	2	
	Boy A1	1	
	Boy A2	2	
Team B –	Girl B1	6	28
	Girl B2	9	
	Boy B1	7	
	Boy B2	6	
Team C -	Girl C1	5	29
	Girl C2	7	
	Boy C1	5	
	Boy C2	11	

By calculating using the individual race scores, the result would have been as follows:

		Individual Race Score	Total Score
Team A –	Girl A1	9	63
	Girl A2	16	
	Boy A1	17	
	Boy A2	21	
Team C –	Girl C1	48	225
	Girl C2	53	
	Boy C1	58	
	Boy C2	66	
Team B –	Girl B1	50	231
	Girl B2	67	
	Boy B1	57	
	Boy B2	57	

Question

Did the race committee comply with the notice of race when it determined each sailor's individual score as their ranking places and not as their individual points?

Answer

No. Under rule A4 (Low point and Bonus Point Systems), a boat is scored points according to finishing place in each race. Rule A2 states that a boat's series score (final score) shall be the total of her race scores, excluding any discards.

The notice of race specifies that the Team Overall ranking would be made by adding the final scores of the competitors of each team. To establish the Team Overall Ranking, the race committee should have added the number of points each boat had in the series and not their positions in the ranking list.

ISAF Racing Rules Question and Answer Service



F 010

Q&A 2009-031

Published: 23 June 2009

Situation:

At the end of a regatta, after the prize giving, the RO discovers that the tie breaking system he used was the wrong one and some tie breaks were wrong, including the silver and bronze which should have been reversed.

Question 1:

Is the RO allowed to correct the results?

Answer 1

Rule 90.3 (a) places the responsibility for scoring on the race committee as a whole. If the race officer becomes aware of a mistake, he must refer the matter to the race committee. The race committee may correct any mistake for which it was responsible. In doing so, it is scoring the boats as they should have been scored had the race committee not made an error so that action is not one that would worsen a boat's score as provided in A5.

Question 2:

If the answer to question 1 is affirmative, then how long after the end of the regatta?

Answer 2

There is no time limit but it will depend. The time elapsed since the end of the regatta is only one factor. If the event was being used as selection for another event that has not yet happened, correction is necessary. The importance of the event and the value of prizes are other factors.

Question 3:

If the answer to question 1 is affirmative does the RO need the permission of the PC/jury?

Answer 3

No permission is needed, but, if the race committee becomes aware of a scoring mistake after the end of an event, it might wish to consult the protest committee or the international jury before deciding whether to issue corrected results.

Question 4:

If the answer to question 1 is affirmative, does it apply to other scoring mistakes, such as those brought in by competitors?

Answer 4:

Yes

ISAF Racing Rules Question and Answer Service



F 011

Q&A 2010-23

Published: 9 June 2010

Situation:

At the end of a series, boat A and boat B had the same total score and the same race scores when listed in order of best to worst.

In one of the races both boats received 3 points:

Boat A received 3 points according to her position when crossing the finishing line, and boat B received her 3 points as RDG.

Question 1:

For purpose of tie breaking, does a score based on a boat's finishing position in a race have equal standing as a score given as redress to a boat that did not cross the finishing line?

Answer 1:

Yes, rule A8 refers to race scores. How the scores were acquired is irrelevant.

Question 2:

Would the answer be the same if the boat that was given redress had actually finished the race?

Answer 2:

Yes, see answer 1.

ISAF Racing Rules Question and Answer Service



Section G

Race Management Practices and Policies

- G1** Special sailing instruction to allow shortening races for safety reasons even after some boats have crossed the finishing line.
 - G2** When the race committee observes a boat touching a mark.
 - G3** Posting OCS lists at the windward mark
 - G4** About abandonment in match racing. Where to draw the line for what would be an improper action by the race committee.
 - G5** Changing the meaning of Race Signals in the sailing instructions
 - G6** When sailing clubs mix responsibilities for club regattas
 - G7** Race committee procedures for sighting the starting line.
 - G8** When using VHF to recall boats.
-

Other Questions that may be relevant:

C2, D1, D3, D4, D5, E1, E2, E4, E5, E6, E7, E8, F1, F2, F3, F4, F5, F6, F7, F8, F9, F10, J2, J7, J8, J9, M2, N1

ISAF Racing Rules Question and Answer Service



G 001

Q&A 2009-009

Published: 09 January 2009

Situation

In an offshore race a fleet of eleven Hobie 16 catamarans passed through gate 1. Winds were light and variable except in squalls. Visibility at times was severely affected by the rain.

A sailing instruction stated that:-

“If in the sole discretion of the Race Committee, boats cannot be permitted for safety or other reasons to complete a leg of a course or it is not possible to finish a leg, boats will be scored at the time that they passed through the previous gate. This amends RRS 35 and Appendix A4.”

After discussion with the race officer the safety controller at the rear of the fleet was given discretion to stop racing with sufficient time to be able to pass dangerous reefs before nightfall. Accordingly half an hour after this discussion, towing commenced. Eight boats were taken under tow, some only accepting the tow on the basis that they were being instructed to stop racing. However from the time that the discussion with the race officer ashore had taken place all communication was lost between the race officer, the safety controller and safety boats at Gate 2.

Whilst the eight boats at the rear of the fleet were being taken under tow the three remaining boats continued to race.

After the eight boats had been taken under tow the three remaining boats passed through gate 2 which had still had no contact with the safety controller and the race officer. No abandonment, shorten course or other signals were shown as the three boats passed through gate 2. A safety boat at gate 2 advised the remaining three boats (out of sight of, or contact with the rest of the fleet) that the race was still in progress and stated that they could continue racing.

Boats were initially scored at the time they passed through gate 1 but then the scoring was changed to score the boats which passed gate 2 in the order they passed through gate 2 with other boats scored as for a retirement.

Following the change in scoring redress was requested by a boat in the second group of eight boats which had been instructed to take a tow. Redress was also requested by a boat in the leading group of three boats. Both parties were present, together with the race officer at the redress hearing.

Redress was granted because of errors and omissions made by the race committee. The protest committee decided to score the leg on the basis of the time and order of passage through gate 1 on the basis of the sailing instruction quoted above being fairest to all.

Question 1

Is there conflict between rule 4 and the sailing instruction quoted above?

Answer 1

No. The race committee may always shorten or abandon for safety reasons. Furthermore, in some circumstances and particularly with juniors, a sailing instruction that requires a boat to accept help when the race committee decides she is in need of help will be valid.

Question 2

Should the sailing instruction have also referred to rule 32?

Answer 2

Yes. The last sentence of rule 32.2 should have been specifically referred to, stating that rule 32.2 had been changed so that the course could be shortened after the first boat crossed the new finishing line.

Question 3

To make the intention of the race committee more clear, should there have been reference in the sailing instruction to the race being "shortened" at the previous gate.

Answer 3

Yes.

Question 4

Provided that there is a clear instruction in the sailing instructions can the race be shortened in this way without the use of flag or other signals.

Answer 4

Yes. The sailing instruction should include a reference to Race Signals 'S' and state the change.

ISAF Racing Rules Question and Answer Service



G 002

Q&A 2009-012

Published: 09 January 2009

Situation

At a rounding mark the race committee noticed a boat touching the mark. There were several other competitors near by, and it was obvious that they witnessed the touch. No protests were lodged and the offending boat did not take a One-Turn Penalty.

Question 1

What action should the race officer take?

Question 2

In the same scenario, would it be different if no other competitors were around at the time of the breach?

Answer

Sailing is a self policing sport. Boats are expected to promptly take a penalty when appropriate. The primary responsibility for protesting breaches of the rules is with the competitors, not the race officials.

A race committee should not normally protest for a breach of rule 31 unless that breach appears to be an apparent breach of good sportsmanship (rule 2). Examples are:

- deliberately touching the mark in order to gain an advantage
- failing to take a penalty after knowingly touching a mark

If the race committee is satisfied that the boat knew it touched a mark and took no penalty and did not protest another boat (for causing the incident), the race committee should protest even if other boats are in the vicinity. Those other boats may well have been focused on their own mark rounding and missed the incident.

ISAF Racing Rules Question and Answer Service



G 003

Q&A 2010-010

Published: 2 March 2010

Situation:

The Sailing Instructions included:

Recalls

The Race Committee may display at the first mark, or on the Race Committee signal boat in case of a General Recall, the sail number or bow number of those boats identified as OCS and/or ZFP. The failure to post or an incomplete or wrong posting will not be grounds for redress.

As this sailing instruction does not place an obligation on the boats, sailors cannot be in breach of it.

Boat A believed that she started correctly but close to the line. Her number was posted by the race committee at the windward mark as being OCS. When seeing the posting boat A stopped racing and sailed off the course. Ashore after racing, boat A requested redress.

The protest committee decided that the conditions to consider redress were met and that the race committee made an error in the OCS sighting and recording procedure, and that through no fault of her own boat A was incorrectly called OCS.

Question 1:

Given the last sentence of this sailing instruction, 'The failure to post or an incomplete or wrong posting will not be grounds for redress', is it correct for the protest committee not to grant redress?

Answer 1:

The protest committee may consider redress for an incorrect OCS call. However, the sailing instruction explicitly stated that a wrong posting would not be grounds for redress. Furthermore, the sailing instruction did not require a boat whose number was displayed at the first mark to retire from the race.

When boat A retired from the race she did not get a finishing position and this was a direct result of her own action. Boat A was at fault in deciding to retire and does not therefore meet the test of 'through no fault of her own'. In addition, since the score for OCS and DNF were the same, her score was not made significantly worse by any improper action of the race committee.

Should the protest committee decide that the conditions for redress were met, the only redress available would be to score boat A DNF.

Question 2:

If the sentence 'The failure to post or an incomplete or wrong posting will not be grounds for redress' was not included in the sailing instructions, may the protest committee grant redress to boat A by deciding she should be recorded as starting properly?

Answer 2:

Yes, but her score would still be DNF since she retired from the race. See Answer 1.

Question 3:

If the answer to question 2 is yes, may the protest committee decide that sailing off the course at Mark 1 in compliance with an SI also results from a race committee error? May the protest committee grant average points from other races to make as fair an arrangement as possible? Or should sailing off the course be considered as not meeting the test of 'no fault of her own', so the protest committee may grant reinstatement for starting, but the result is boat A should be recorded as starting and scored DNF for not competing the course?

Answer 3:

Not relevant since sailing off the course is not an action in compliance with the sailing instruction, as the instruction does not place any obligations on any boats. See also the reasons given in Answer 1. If however a protest committee had unnecessarily considered whether boat A was OCS, and had decided that she was not OCS, then the appropriate redress would be to change OCS to DNF.

Comment:

The procedure described in the sailing instructions in this case is unusual and confusing for the boats. The practice of displaying a boat's number at the windward mark is normally restricted to a boat that failed to start or has broken rule 30.3, where a clause requiring such boats to retire immediately is included in the sailing instructions. Instruction 14.6 of Appendix LE (Expanded Sailing Instruction Guide available at the ISAF website) provides appropriate wording for this procedure.

ISAF Racing Rules Question and Answer Service



G 004

Q&A 2009-015

Published: 21 January 2009

Situation

At a Match Racing regatta the sailing instructions state

“Rule 32 is deleted and replaced with: ‘After the starting signal the RC may abandon or shorten any match for any reason, after consulting with the match umpires when practical.’”

The Race Committee subsequently abandons a match when the lead boat is within a few boat lengths of crossing the finishing line.

When the match umpires enquire why the race was abandoned, the race officer states “the Organising Authority directed me to abandon as the local team was not going to win the match.”

Question

Does the abandonment of the race by the race committee constitute an improper action in terms of rule 62.1(a)?

Answer

Yes.

A race committee must be impartial and conduct the racing of all matches in good faith and in the best interests of all the competitors and the regatta as a whole.

The “*any reason*” provided in the sailing instructions can be anything the race committee sees as contributing towards a practicable, fair and equal competition and allows the race committee to handle issues as they arise as expeditiously as possible.

The decision to abandon lies solely with the race committee, although they are required to consult with the match umpires when practical. Provided the race committee acts impartially and in good faith when deciding to abandon a match, that action cannot be considered to be improper.

In this particular case however, the organising authority and the race committee have not acted impartially or in good faith. They have deliberately acted to assist one local competitor against all others and that action is both unfair to all other competitors and improper.

The Chief Umpire should include this incident in the ISAF report form including the identity of the Race Officer.

ISAF Racing Rules Question and Answer Service



G 005

Q&A 2010-015

Published: 19 May 2010

Question:

The Racing Rules of Sailing rule 25 states that ...'The meanings of the visual and sound signals stated in Race Signals shall not be changed except under rule 86.1(b).'

Rule 86.1(b) is not mentioning the Racing Signals.

Does this mean that

- a) it is permitted to change the meaning of the Race Signals in the sailing instructions, because rule 86.1(b) states that the sailing instructions can change a racing rule, except some certain rules, or
- b) it is not permitted to change the meanings of the visual and sound signals stated in Race Signals, because rule 25 prevent this and rule 86.1(b) does not have exceptions?

Answer:

It is permitted to change the meaning of the Race Signals in the sailing instructions as rule 25 is not included in the rules that can not be changed in rule 86.1(a).

When rule 25 states 'except under rule 86.1(b)', that refers to the requirement that when the sailing instructions change a rule or the definition of the zone around marks, it must also refer specifically to the rule or definition being changed and state the change.

ISAF Racing Rules Question and Answer Service



G 006

Q&A 2010-016

Published: 19 May 2010

Situation:

Two yacht clubs (A and B) agreed to combine some races in two series normally run individually by Clubs A and B.

Race 1 of the Club A series was sailed under the notice of race and sailing instructions of the Club B series. Club B was therefore the organizing authority of this race. The sailing instructions of Club A confirmed that for race 1, the notice of race and the sailing instructions of the Club B series applied and that "This statement takes precedence over the Club A NOR and SI series". The Club B race officer set the course for the race.

The wind conditions were such that the entrants of the Club A series could not finish by the 16:00 time limit stated in the Club B sailing instructions. In the Club A sailing instructions, the time limit was 18:00 for race 1.

One Club A boat finished around 17:00 and lodged a request for redress to Club A alleging an error or omission on the part of the race committee.

Question:

Club A's sailing instructions made it clear that race 1 of their series was to be sailed under the notice of race and sailing instructions from Club B.

Would a protest committee appointed by Club A have any jurisdiction to hear the request for redress in race 1?

Answer:

No. Club A has no jurisdiction unless Club B appointed the protest committee of Club A or a joint protest committee to deal with the request.

Under rules 89.2(b) and 91(a) the organizing authority or the race committee shall appoint a protest committee. Club A's sailing instructions clearly gave precedence to Club B's notice of race and sailing instructions for this race which resulted in the race committee from Club B conducting the race and Club B was also the organizing authority as its notice of race took precedence.

Only the organizing authority or the race committee of Club B could appoint the protest committee.

ISAF Racing Rules Question and Answer Service



G 007

Q&A 2010-18

Published: 24 May 2010

Situation:

A starting sequence with flag P as preparatory signal.

Approximately 6-7 seconds before the start several boats were over the line close to the pin end, and the race officers on the signal vessel lost view of the orange line flag and staff on the pin end boat. The orange flag did not become visible from the signal committee vessel until after the start.

Four boats were called OCS by the race officer on the pin end boat.

1-2 seconds before the start the race officer on the signal boat observed another boat near the pin end crossing the starting line and called it OCS too. Since the orange flag was not visible, he used a landmark (house roof in the hill a few miles distant) as an extension of the starting line.

Question 1:

Can the starting line really be that fuzzy?

Answer 1:

The starting line is not fuzzy, it is between the staffs displaying orange flags on the two starting marks (race committee boats).

Question 2:

Did this method meet the definition of starting line as described in the sailing instructions (i.e. 'The starting line will be between staffs displaying orange flags on two race committee boats')?

Answer 2:

Yes. As long as there were orange flags displayed from staffs on the starting marks, the requirements of the sailing instructions are met.

Question 3:

May these facts be grounds for redress if lodged by the boat?

Answer 3

The facts stated do not describe any error or omission of the race committee. For a boat to be given redress after being scored OCS, conclusive evidence must be presented to the protest committee that the race committee has made an error.

NOTE

Different methods may be used to sight the starting line, depending on various parameters such as the number and the type of boats on the line, the conditions and the available infrastructure. The choice and the responsibility lie with the race committee. For the race committee to use a transit to sight the line is not an improper action.

ISAF Racing Rules Question and Answer Service



G 008

Q&A 2010-21

Published: 7 June 2010

Situation:

The sailing instructions at an event stated:

‘In the case of infringements of rules 29.1 and 29.2 RRS, The Race Committee shall call as soon as possible on VHF channel 72, the sail numbers or bow numbers of those who have broken the rule. Failure / partial or poor radio signal reception / transmission, cannot be grounds for a request for redress.’

Question:

Considering that a delay in radio transmission is not listed as reason for not requesting redress, what is the meaning of ‘as soon as possible’ as used in this sailing instruction? Would 2 minutes be considered reasonable or could a 2 minutes delay be grounds for redress?

Answer:

The term "as soon as possible" is ‘used in the sense ordinarily understood in nautical or general use.’ (See ‘Terminology’ in the Introduction to the Racing Rules of Sailing). The announcement should be made as soon as practicable after the starting signal when all such boats have been identified. This time will vary from race to race.

A late recall should normally be considered as ‘failure’ and would not be grounds for a request for redress under this sailing instruction. However, in this case, the sailing instruction did not meet the requirements of rule 86.1(b) to specifically refer to the rule (rule 62.1(a)) being changed so, a protest committee would not be prevented from considering redress.

Race committees should take care to ensure that words used in sailing instructions reflect their intentions.

ISAF Racing Rules Question and Answer Service



Section H

International Jury

- H1** Rule N1.1 and International Jury members on signal and finishing boats.
 - H2** A question relating to International Juries and when they are properly constituted.
 - H3** A clarification about submitting questions about Jury decisions.
-

Other Questions that may be relevant:

J3, J5, N2

ISAF Racing Rules Question and Answer Service



H 001

Q&A 2002-001

Revised: 12 January 2009

Question 1

Often in large regattas a member of the international jury may be on a signal boat or finish boat as an observer. Does this break rule N1.1.

Answer 1

No.

Question 2

In events with multiple racing areas, may a member of an international jury when asked to do so by the organizing authority, assist or advise the race committee on a particular race area, without breaking N1.1, if that judge takes no part in hearing protests from that race area?

Answer 2

If asked by the race committee, the jury shall advise or assist them on any matter directly affecting the fairness of the competition. This could be done by having one member onboard the race committee signal boat.

In such a case, rule N1.1 does not prohibit a member of the jury from deciding protests or requests for redress from that race course. However, when a member of the jury has been assisting or advising the race committee on a matter that is the subject of a hearing, it is advisable for that judge to serve only as a witness and not to participate in the decision, if the composition of the jury permits.

ISAF Racing Rules Question and Answer Service



H 002

Q&A 2003-001

Revised: 12 January 2009

Question 1

When is an International Jury constituted?

Answer 1

Provided that all the requirements of rules N1.1, N1.2, and N1.3 are met, an International Jury is properly constituted when at least five members have accepted their invitations, and the judges and the organizing authority agree to the terms of service.

Question 2

Five judges are appointed to the International Jury by the organizing authority in accordance with rules N1.1, N1.2 and N1.3. Due to illness or an emergency, only four members arrive at the event. Provided that the four remaining members are from three different national authorities (or two different national authorities if the event is in Group M, N or Q), is the jury a properly constituted International Jury?

Answer 2

Yes. However, the jury would only be properly constituted if all the requirements of rule N1.5 are met. In addition to the nationality requirements, the jury must have been previously and properly constituted with at least five members, and the reason for fewer members must have been for illness or emergency.

Rule N1.5 is an emergency provision that applies only when the unusual circumstances referred to in the rule arise, and the organizing authority has not succeeded in finding a replacement. An organizing authority must continue to make every effort to appoint replacements that will bring the jury into compliance with rules N1.1, N1.2 and N1.3 from the time it becomes aware of the illness or emergency.

ISAF Racing Rules Question and Answer Service



H 003

Q&A 2009-041

Published: 16 December 2009

Question:

Will the Q&A Panel confirm or correct decisions made by international juries?

Answer:

No. The role of the Q&A Panel is to promote an understanding of the rules and the use of correct procedures. The Race Officials Committee and the Racing Rules Committee have both concluded that serving as the equivalent of an appeals committee to confirm or otherwise a jury's decision is neither desirable nor appropriate and neither the ISAF Regulations nor the Racing Rules of Sailing provide for the Panel to carry out that function.

ISAF Racing Rules Question and Answer Service



Section J

Protests, Hearings, Appeals & Procedures

- J1** Signalling a yellow flag penalty after a general recall.
 - J2** Notifying boats of a protest by informing the coach, rules advisor or other representative.
 - J3** The weighing and credibility of evidence in protest hearings.
 - J4** When a protest committee protests a boat under rule 60.3(a)(2).
 - J5** About denial of appeal and national prescriptions.
 - J6** Compelled to break a rule by an unidentified boat breaking a rule.
 - J7** Conditions for a protest committee to reinstate an abandoned race
 - J8** Protest time limit when the race time limit runs out
 - J9** Redress when boats get entangled with marks
-

Other Questions that may be relevant:

A2, F3, F6, F7, F8, F9, F10, G4, G6, G8, H1, H2, K1, N1, N2

ISAF Racing Rules Question and Answer Service



J 001

Q&A 2004-008

Revised: 12 January 2009

Situation

During the starting sequence, the judges observe a boat's crew breaking rule 42. While the judges approach the boat to penalize her, the race committee signals a general recall. Approximately 15 seconds after the general recall has been signaled, the judges penalized the competitor by making a sound signal with a whistle, pointing a yellow flag at her and hailing her sail number.

Question 1

Can the judges penalize a competitor under rule P1 after a general recall has been signaled?

Answer 1

Provided that the breach of rule 42 occurs before the general recall is signaled, it is proper for the judges to penalize a boat as soon as possible, even if the penalty is being signaled after the general recall is signaled.

Question 2

Does this penalty count in the numbering of protests under rule P2?

Answer 2

Yes, see rule P3.

ISAF Racing Rules Question and Answer Service



J 002

Q&A 2007-006

Revised: 12 January 2009

Question

May a race committee or protest committee satisfy its obligation under rule 61.1 to notify the boat of a protest by informing the boat's coach, rules advisor or other representative?

Answer

When a boat has registered a coach, rules advisor or other representative or when a person is clearly representing a boat, the race committee or protest committee complies with its obligations in rule 61.1(b) or (c) to inform the boat of the protest when it informs the representative.

ISAF Racing Rules Question and Answer Service



J 003

Q&A 2009-011

Published: 09 January 2009

Question:

When a protest committee in a fleet race, after hearing the parties and considering all evidence, comes to a judgement

- that the statements of the parties have the same credibility, and
- that the evidence presented by the parties and the evidence considered necessary by the protest committee (pro and contra) also have also the same credibility,

shall the protest committee then write this down as a fact (rule 63.6) and reject the protest?

Answer:

Rule 63.6 requires a protest committee to take evidence, to find facts and to base its decision on the facts found. Rule M3.3 expands on this and instructs protest committees to resolve doubts one way or the other, if necessary by calling the parties back for further questions.

Resolving doubts may not be easy but experienced judges should be able to ask relevant questions and gradually build up a picture or diagram of times, distances and courses that are the essential facts on which a decision can then be taken.

With the exception of rule 69 hearings, a protest committee has only to find that, on the balance of probabilities, one boat is more likely to have broken a rule than the other. When relevant, the following guidance is available to protest committees:

- (1) Rule 18.2(d) in the RRS gives guidance when the protest committee has reasonable doubt that a boat obtained or broke an overlap in time.
- (2) The umpiring principle of the last point of certainty is also to some extent valid in protest hearings.
- (3) In Case 50, a boat required to keep clear fails to do so if the right-of-way boat takes avoiding action because of a genuine and reasonable apprehension of a collision

The questioner's assertion that "if a protest committee writes down as a fact that after investigation of all reasonably available facts there is not enough evidence for the claim of the protestor" is misplaced. This is not a fact but a conclusion. Protest committees must be careful to distinguish between facts and conclusions, which are based on facts found.

ISAF Racing Rules Question and Answer Service



J 004

Q&A 2009-039

Published: 10 December 2009

Situation:

During the hearing of a valid protest, the protest committee learns that a boat, that was not a party to the hearing, may have broken a rule. The protest committee decides to protest the boat under rule 60.3(a)(2). The committee informs the boat immediately, and then proceeds with the protest against the new boat within the current hearing.

No new protest is submitted in writing.

The protest committee decides to penalize the new boat.

Question 1:

May a new protest, under rule 61.1(c), be an oral protest, considering that rule 61.2 clearly states: "A protest shall be in writing..."?

Answer 1:

No. Rule 61.2 requires that a protest is in writing. An oral protest does not comply with rule 61.2.

Question 2:

If the answer to Question 1 is No – will the decision of the protest committee still be valid - or will this make it void?

Answer 2:

Any decision of the protest committee is valid until either the protest committee, acting under rule 66, realises that it had made an error and changes its decision about the validity of the protest, or until the decision has been reversed or changed on appeal.

Question 3:

Would the answer to Question 2 change if the protest committee has asked and the representative of the new boat confirms that she is ready for the hearing and does not need more time to prepare? Would such consent be considered as consent to be a party to a protest hearing; and if so, does such consent eliminate the necessity of a written protest?

Answer 3:

While the protest committee procedure is not correct, the decision remains valid until it is validly changed, as in answer 2.

Question 4:

Could what happened in the room between the protest committee and the new boat be considered as a “hearing”, or was it just a conversation?

Answer 4:

Yes, it was a “hearing” under rule 63, but see also answer 2.

Question 5:

The boat wrote to the protest committee asking that it change the decision. The protest committee refused and the boat appealed to the National Authority under rule 70. The National Authority upheld the decision of the protest committee.

What meaning and status has then the National Authority decision, in case the decision of the protest committee was invalid (or null and void).

Answer 5:

The decision of the national authority is final, and it is binding on the protest committee and the parties. See rule 71.4.

ISAF Racing Rules Question and Answer Service



J 005

Q&A 2009-040

Published: 10 December 2009

Question 1:

The national authority has prescribed to rule 70.5(a) that its approval is required for the right of appeal to be denied when it is essential to determine promptly the result of a race that qualifies a boat for a subsequent event. The organizing authority for an event where this is relevant appoints an international jury that complies with rule N1, but does not ask the national authority for its approval to deny the right of appeal. Can the jury's decisions be appealed?

Answer 1:

No. Since the international jury was properly constituted in compliance with rule N1, there shall be no appeal from its decisions. The approval of the national authority that is required in rule 70.5(a) is only to deny the right to appeal at an event where the conditions in (a), (b) or (c) are met, but without a properly constituted international jury.

Question 2:

If the national authority also had a prescription to rule 91(b) requiring its approval for the appointment of an international jury, and there was no such approval, would the answer to Question 1 be different?

Answer 2:

Yes. In this case, the international jury would not be properly constituted in compliance with Appendix N1 without the approval of the MNA (see rule N1.1), and any decisions could be appealed. It would not make a difference whether the international jury was aware that such approval had not been obtained.

Question 3:

If the national authority had a prescription to rule 91(b) requiring its approval for the appointment of an international jury and that approval was not obtained, how would this affect the denial of the right to appeal under rules 70.5(a), (b) and (c)?

Answer 3:

Rules 70.5(a), (b) and (c) allow the denial of the right of appeal at some events against decisions of a protest committee that is not an international jury. If the specific requirements of any of those rules have been met, the decisions cannot be appealed. This would be the case irrespective of any approval for an international jury under rule 91(b), because the protest committee would not need to be an approved international jury.

However, where there was an unapproved international jury at an event to which rules 70.5 (a), (b) or (c) did not apply, the competitors would have the right to appeal any decisions because such a jury would not comply with rule N1.1. The national authority would then have to hear any appeal it received against a decision of that jury.

ISAF Racing Rules Question and Answer Service



J 006

Q&A 2010-003

Published: 14 January 2010

Assumed Facts for Questions 1 and 2:

Boats are approaching the port-hand windward mark on the starboard-tack layline. Some are overlapped. Boat X, sailed single-handed, touches the mark and does not take a penalty. The race committee observes this and lodges a valid protest against boat X.

In the hearing, boat X agrees that she touched the mark, but says that she was compelled to do so because a windward boat did not give her mark-room and did not keep clear. She says that she did not believe she was required either to take a penalty, or to protest the other boat. She does not know the identity of the other boat. The protest committee hears evidence from boat X of an overlap at zone entry inside the unknown boat. There is no evidence available from the race committee or from any other boat as to any overlap by boat X with another boat. The race committee witness cannot exclude the possibility that another boat was nearby and is certain that no boat took a penalty at that mark.

Question 1:

In the absence of a protest by boat X against an identified boat for not giving mark-room, is a protest committee entitled to exonerate boat X if it has no grounds for doubting her evidence, but no possibility of confirming that evidence?

Answer 1:

Although whenever possible it would be wise to protest a boat that compels you to break a rule, this is not in itself a requirement. However, without a protest and testimony from other boats or witnesses, the protest committee may not be able to conclude, based on its facts found, that another boat involved in the incident compelled you to break a rule. Without such a conclusion, exoneration under rule 64.1(c) would not be available for the boat that claims she was compelled to break a rule.

Normally, a boat should make sure to positively identify the other boat in an incident, however, mark rounding in single-handed classes may be very crowded and it is not uncommon that the competitors lose track of the identity of other boats rounding at the same time. For a protest to be valid, the protestee must be identified, and there are cases when this will not be possible. Hence, without a correct identification of the other boat, a protest has to be found invalid.

In itself, the lack of a protest by boat X and the lack of identification of the unknown boat, does not make it impossible to exonerate boat X. The protest committee needs to find as facts that the incident occurred as described by boat X and normally the protest committee will need to consider more than just boat X's testimony. Without any further testimony as basis for facts found and conclusions, the likelihood of exoneration is not big.

Question 2:

If the answer to question 1 is No, does boat X break rule 2?

Answer 2:

It depends. Under the basic principle 'Sportsmanship and the Rules', boat X is expected to enforce the rules. Under rule 2 boat X should compete in compliance with this principle. But boat X may only be penalized under rule 2 if it is clearly established that this principle has been violated.

Assumed Facts for Questions 3 and 4:

Boats are approaching the port-hand windward mark on the starboard-tack layline. Some are overlapped. Boat A, sailed single-handed, is seen by boat B, astern, to touch the windward mark, and not take a penalty. Boat B lodges a valid protest against boat A, referring to rule 31.

In the hearing, boat A agrees that she touched the mark, but says that she was compelled to do so because a windward boat did not give her mark-room and did not keep clear. She does not know the identity of the other boat. Boat B's evidence is that there was indeed another boat that appeared to have failed to keep clear of and failed to give mark-room to boat A. However, boat B is also unable to identify the boat concerned.

Question 3:

In the absence of any identification of the boat that may have caused boat A to break rule 31, is the protest committee entitled to exonerate boat A?

Answer 3:

Yes. Provided the protest committee concludes, based on its facts found, that an unidentified boat did break a rule and compelled boat A to break rule 31, it may exonerate Boat A for breaking rule 31 under rule 64.1(c).

The testimony from boat B that there was indeed a windward boat that appeared to fail to keep clear and to give mark-room, makes it more likely that the protest committee can find sufficient facts to conclude that boat A was compelled to break rule 31.

Question 4:

If the answer to question 3 is No, does boat A break rule 2?

Answer 4:

Not applicable.

ISAF Racing Rules Question and Answer Service



J 007

Q&A 2010-005

Published: 1 February 2010

Situation:

Making the assumption that the race officer met the requirement of rule 32.1(e) 'However, after one boat has sailed the course and *finished* within the time limit, if any, the race committee shall not *abandon* the race without considering the consequences for all boats in the race or series.'

Question 1:

May a protest committee reinstate a race that has been abandoned by the race committee before any boat has finished, but in which the race committee has scores from the previous mark?

Answer 1:

The assumption stated implies that one boat has sailed the course and finished. The question says that the race committee abandons the race before any boat finished. If an abandonment signal is made before any boats finish, irrespective of whether any boats thereafter crosses the finishing line, the last part of rule 32.1 is not relevant.

More generally, any abandonment, regardless of when it was signalled or otherwise announced, may give rise to a request for redress or a consideration of redress. If the protest committee decides that the race was improperly abandoned, and the other criteria of rule 62 are met, then the protest committee may give redress. That redress may be to score the race, and the redress may be based upon the last recorded positions before the abandonment was signalled.

Question 2:

May a protest committee reinstate a race that has been abandoned by the race committee when at least one boat has finished within the time limit, if any?

Answer 2:

Yes. See Answer 1.

Question 3:

May a protest committee reinstate a race that has been abandoned by the race committee after the race has been completed and all boats provisionally scored?

Answer 3:

Yes. See the second paragraph of Answer 1. In such a case, the redress should normally be to score all boats according to the provisional results.

ISAF Racing Rules Question and Answer Service



J 008

Q&A 2010-006

Published: 8 February 2010

Situation:

In a coastal race, the race committee gave finishing positions to two boats that had finished within the time limit, and scored all the other boats DNF. The sailing instructions changed the protest time limit in rule 61.3 from two hours to 60 minutes:

One of the DNF boats requested redress.

Question:

What was the time limit for lodging a request for redress? Was it:

- (a) within two hours after the expiry of the time limit, assuming that this was an 'incident' for the purposes of rule 62.2?
- (b) within sixty minutes after the finishing time of the second boat, if in fact the end of the time limit could not be said to be a relevant 'incident'?

Answer:

The Situation does not state the reasons for asking for redress, but the Question implies that the boat wishes to contest being scored DNF.

If so, the time limit was neither of the two suggested options. The incident was when the boat learned that she had been scored DNF. The time limit was, at the earliest, two hours after that moment. It is quite possible in coastal races that a boat will not receive event scores for some time after the race, or that the results are radioed ashore and posted while the boats are still afloat. A protest committee would have good reason to extend the two-hour time limit when a request for redress was lodged within a reasonable time.

It should also be noted that a request for redress based solely on being scored DNF for finishing outside a time limit will not succeed if a sailing instruction changes rule 35 under rule 86.1(b) and restricts finishing places to boats finishing within that given time limit. See L15.2 as an example.

If however, the request for redress is based on a claim that a particular issue has caused the boat to finish outside the time limit, then being scored DNF will not be the incident. For example, a boat may claim to have been delayed by a misleading sailing instruction (rule 62.1(a)); or by physical damage caused by another boat (rule 62.1(b)); or by time taken to give help (rule 62.1(c)). In these situations, the rule 62.2 time limit for delivering a request for redress will be the later of 60 minutes after the last boat in the race finishes and two hours after the incident. The time limit may also be extended when there is a good reason to do so. The question does not state whether any of the boats scored DNF finished, albeit out of time. If one or more did, that will identify the last boat in the race to finish.

For a request for redress of this sort, once found valid, to succeed, the protest committee would need to be satisfied not only that the boat was delayed, but also that she would have finished within the time limit had she not been delayed.

ISAF Racing Rules Question and Answer Service



J 009

Q&A 2010-008

Published: 15 February 2010

Question:

Is a boat entitled to pass as close to any mark as she pleases without getting entangled with its ground tackle? If a boat gets entangled and thereby loses time, prejudicing her finishing position, is she entitled to redress?

The Race Management Manual emphasizes the obligation of race committees to lay marks in such a way that boats cannot get caught, but there is a view that a boat must take some responsibility, and if she gets caught on the ground tackle she is partly at fault, which would deprive her from the possibility of getting redress ('... through no fault of her own...')

Answer

Current, wind, water depth, tidal range, the type of mark, its weighting and the characteristics of the boat passing it can all affect the possibility of entanglement with a mark's ground tackle. Good seamanship requires a boat to make allowance for these to the best of her ability, and she should not assume that it will always be safe to pass as close to the mark as is physically possible. This will also affect the amount of mark-room from other boats to which she is entitled. The less she can show she took these factors into consideration, the more likely it will be that she was at fault.

For a boat that gets entangled in a mark's ground tackle to be entitled to redress under rule 62.1(a), there must first be an improper action or omission by the race committee. This will be so only if there is a risk of entanglement that boats could not reasonably be expected to anticipate and the race committee could clearly have done something different that would have avoided or substantially reduced this risk



ISAF Racing Rules Question and Answer Service

Section K

Match Racing

K1 About abandonment in match racing. Where to draw the line for what would be an improper action by the race committee.

Other Questions that may be relevant:

B3, B7, B12, D2, M1, M4, M5

ISAF Racing Rules Question and Answer Service



K 001

Q&A 2009-015

Published: 21 January 2009

Situation

At a Match Racing regatta the sailing instructions state

“Rule 32 is deleted and replaced with: ‘After the starting signal the RC may abandon or shorten any match for any reason, after consulting with the match umpires when practical.’”

The Race Committee subsequently abandons a match when the lead boat is within a few boat lengths of crossing the finishing line.

When the match umpires enquire why the race was abandoned, the race officer states “the Organising Authority directed me to abandon as the local team was not going to win the match.”

Question

Does the abandonment of the race by the race committee constitute an improper action in terms of rule 62.1(a)?

Answer

Yes.

A race committee must be impartial and conduct the racing of all matches in good faith and in the best interests of all the competitors and the regatta as a whole.

The “*any reason*” provided in the sailing instructions can be anything the race committee sees as contributing towards a practicable, fair and equal competition and allows the race committee to handle issues as they arise as expeditiously as possible.

The decision to abandon lies solely with the race committee, although they are required to consult with the match umpires when practical. Provided the race committee acts impartially and in good faith when deciding to abandon a match, that action cannot be considered to be improper.

In this particular case however, the organising authority and the race committee have not acted impartially or in good faith. They have deliberately acted to assist one local competitor against all others and that action is both unfair to all other competitors and improper.

The Chief Umpire should include this incident in the ISAF report form including the identity of the Race Officer.

ISAF Racing Rules Question and Answer Service



Section L

Technical Questions

- L1** A question about the legality of disconnecting the headstay while racing.
 - L2** A question about the use of the Yngling gybing line.
 - L3** A question about boat wax/polish and rule 53.
 - L4** A question about hiking devices and rule 49.1.
 - L5** A question about rule 53, textured surfaces and wet sanding.
 - L6** Questions about rule 42 when rules 49 to 54 do not apply.
 - L7** Using a lead trapeze harness strap buckle (that is a dive weight) and rule 43.1(a).
 - L8** Life line material and the Racing Rules of Sailing.
-

Other Questions that may be relevant:

D3. E4

ISAF Racing Rules Question and Answer Service



L 001

Q&A 2003-007

Revised: 12 January 2009

Question

Is it legal to disconnect the headstay to gybe the boat, or is the headstay required to be attached at all times while racing?

Answer

Forestays, and headsail tacks, may be detached while racing. However, when attached, a forestay must be attached approximately on a boat's centre-line. Class rules may change rule 54 to prohibit racing with permanent rigging detached.

ISAF Racing Rules Question and Answer Service



L 002

Q&A 2008-004

Revised: 12 January 2009

Question 1

Can the Yngling gybing line be considered 'the sheet' referred to in 42.3(c)?

Answer 1

The gybing line permitted by Yngling class rules is not 'the sheet' referred to in RRS 42.3(c).

Question 2

If the answer to Question 1 is 'yes' would the same answer apply if the traveller or vang was used to pump the mainsail?

Answer 2

Not applicable

ISAF Racing Rules Question and Answer Service



L 003

Q&A 2009-001

Published: 09 January 2009

Question:

A supplier claims that application of its product "...has reduced the residual resistance, associated with drag viscous resistance, by 6%." Once applied, this "wax" will last about 60-80 hours of sailing.

Is the use of this product is allowed under the racing rules?

Answer:

Yes.

Rule 53 prohibits the specific action of releasing a substance into the water while racing. Using a preparation prior to racing that is removed by the water contact with the hull does not break rule 53.

Consideration of class rules may result in different answers.

Note:

- The name of the product has been removed from this Q&A and is not an endorsement of any product, rather an interpretation of rule 53 in regards to surface finishes that erode.

This answer has been prepared in consultation with the ISAF Technical Department.

ISAF Racing Rules Question and Answer Service



L 004

Q&A 2009-007

Published: 09 January 2009

The following Questions have been answered without reference to any class rule. Consideration of class rules may result in different answers.

Question 1

Will any rope which is only used to support the hiking of a competitor be considered as a hiking strap as per rule 49.1?

Answer 1

No. However a rope used as described above would be a device as referred to in rule 49.1.

Question 2

Is it possible that a competitor uses more than one hiking strap at the same time?

Answer 2

Yes. In many boats the crew can use the toe/foot straps provided on either side of the boat at the same time. Class rules may restrict this activity.

Question 3

Will the device as shown in the picture below be considered as a hiking strap as per rule 49.1?

Answer 3

No – it is clearly a device designed to allow the body to be positioned outboard.

Question 4

Would the use of the device in the picture while racing break rule 49.1?

Answer 4

Yes. The arrangement may also be in breach of rule 43.1(b) as all the individual components of the device would be included in the term 'hiking harness'.

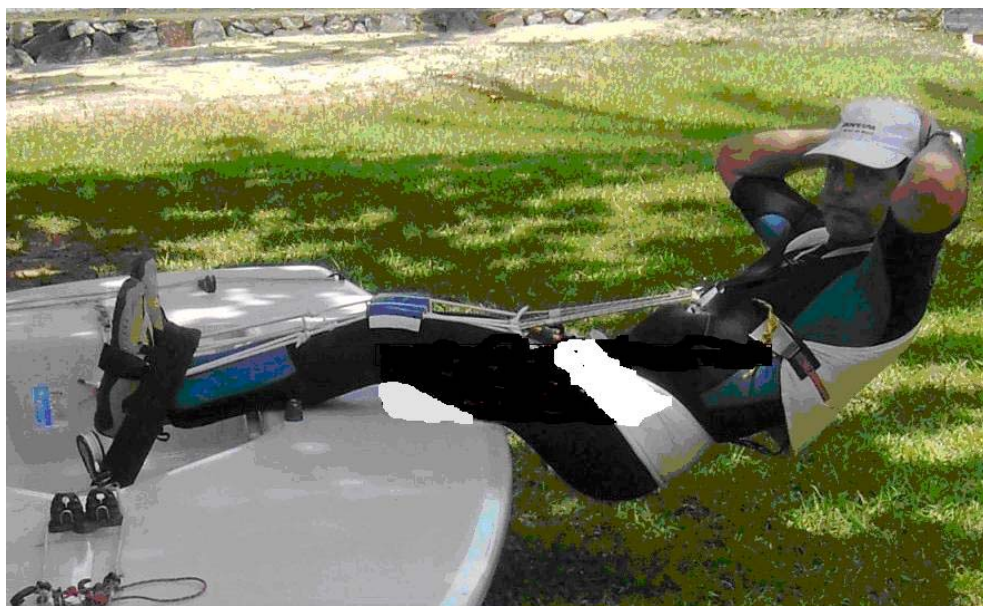

ISAF Racing Rules Question and Answer Service



L 005

Q&A 2009-029

Published: 24 April 2009

53 SKIN FRICTION

A boat shall not eject or release a substance, such as a polymer, or have specially textured surfaces that could improve the character of the flow of water inside the boundary layer.

Question:

Does finishing a hull using wet & dry sandpaper break rule 53 '...specially textured surfaces that could improve the character of the flow of water inside the boundary layer.'?

Answer

No.

Specially textured surfaces have a deliberate pattern. Normal sanding produces a random pattern.



ISAF Racing Rules Question and Answer Service

L 006

Q&A 2009-037

Published: 10 December 2009

Situation

Racing rules 49 to 54 do not apply at the 33rd America's Cup. There are no relevant class rules. Please consider the following systems:

1. Sucking air from multiple points of the sail surface.
2. Expelling air from multiple points of the sail surface.
3. Expelling air from the leech of the sail.
4. An arrangement where air is expelled and sucked from alternating points on the sail surface, where the volume of air that is sucked into the surface is equal with the volume of air expelled.

The sucking and/or expelling of the air would be driven by a powered pump arrangement.

The movement of the air by the pump is itself not providing any net measurable lift; these actions will improve the airflow so the mast / sail arrangement will become more efficient (increasing lift).

Question

Do any of these systems break the racing rules (ignoring rules 49 to 54)?

Answer

The Racing Rules for Sailing have been written based on the historical background of our sport and it is recognized that not all future eventualities or developments can be covered.

Provision exists for class rules to change a number of rules as detailed in rule 86.1(c) and rule 42 is one such rule. Changes to rule 42 could also be made in accordance with rule 86.2. Unless rule 42 has been changed to permit the use of the suggested systems, they would not comply as all four systems rely on pumping or sucking air and therefore the boat would not be competing by using 'only the wind' as stipulated in rule 42.1.

ISAF Racing Rules Question and Answer Service



L 007

Q&A 2009-038

Published: 10 December 2009

Question

Question about the interpretation of the word 'purpose' in rule 43.1(a): *'Competitors shall not wear or carry clothing or equipment for the purpose of increasing their weight.'*

If somebody chooses to use a lead trapeze harness strap buckle that is also a dive weight, is that not a breach of this rule? Even if a buckle is required to hold the harness in place, the choice of a dive weight to do so would appear to be for the purpose of increasing weight. But I see a problem with that argument: pushed to its conclusion, you would have to wear the lightest available gear in order to comply with the rule.

Answer

Using a dive weight as a strap buckle would normally be seen as being used for the purpose of increasing weight and would then be a breach of rule 43.1(a). The protest committee will decide on each individual case brought to them. Rule 43.1(a) applies to all clothing and equipment. However, rule 43.1(b)'s trapeze default harness weight limit of 2 kilograms, coupled with the requirement for the harness to have positive buoyancy, means that the question will not normally arise. If, as permitted by that rule, a class has specified a higher permitted weight for a trapeze harness (maximum 4 kilograms), a protest committee may determine that there is some purpose other than increasing weight, and that doing so does not break rule 43.1(a).

ISAF Racing Rules Question and Answer Service



L 008

Q&A 2010-002

Published: 14 January 2010

The Racing Rules of Sailing 2009 - 2012

- 49.2** When lifelines are required by the class rules or the sailing instructions they shall be taut, and competitors shall not position any part of their torsos outside them, except briefly to perform a necessary task. On boats equipped with upper and lower lifelines of wire, a competitor sitting on the deck facing outboard with his waist inside the lower lifeline may have the upper part of his body outside the upper lifeline.

ISAF Offshore Special Regulations 2010 - 2011

3.14.6 Lifeline Minimum Diameters, Required Materials, Specifications

- a) Lifelines shall be of :
- stranded stainless steel wire or
 - single-braided Dyneema® rope

Question:

Does the term "wire" in RRS 49.2 include Dyneema(R) ropes as defined by OSR 3.14.6 a)?

Answer:

No. Rope of any description can not be considered as wire. Boats wishing to use the provisions of the second sentence of rule 49.2 will need to continue to be equipped with upper and lower lifelines of wire unless rule 49.2 has been changed by the sailing instructions or class rules to allow the use of other materials.

ISAF Racing Rules Question and Answer Service



Section M

Terminology

- M1** When is a boat on a beat to windward?
 - M2** Questions about the term 'Starting Area'
 - M3** Is a finishing line a 'gate'?
 - M4** Questions about the new definition Fetching.
 - M5** When is a boat 'sailing on another leg'.
 - M6** Changing course and rule 16.
 - M7** When touching only the flag on a mark.
 - M8** Paddle test and the exceptions in rule 42.
 - M9** Proper Course and sail configuration.
-

Other Questions that may be relevant:

B2, B3, B5, B6, B13, B14, D1, D2, D4, E1, E3, E4, E5, E7, F1, F5, F6, F7, J2, J6, J8

ISAF Racing Rules Question and Answer Service



M 001

Q&A 2004-006

Revised: 12 January 2009

Question

Except on a beat to windward, rule 42.3(c) permits a boat to pull the sheet or guy to initiate surfing or planing. When is a boat on a beat to windward?

Answer

The phrase 'on a beat to windward' is used in rules 18.1(a) and 42.3(c). For the purposes of each rule, a boat is 'on a beat to windward' when her proper course is close-hauled; when she is 'beating.' Therefore, if a boat is sailing on a leg to the windward mark and the wind direction changes so that the boat's proper course to the mark is no longer close-hauled, then the boat is no longer 'on a beat to windward.'

Similarly, when a boat is sailing on a downwind leg and there is a wind shift so that it is clear the boat's proper course to the mark is close-hauled, then the boat is 'on a beat to windward'.

When judging this, the last point of certainty principle is used. For example, a boat approaching a windward mark on the starboard tack layline gets a lifting shift. The judges need to be certain that the boat's proper course is no longer close-hauled before permitting 'one pump per wave'. If there is any doubt, the judgment will be that the boat is still 'on a beat to windward'.

ISAF Racing Rules Question and Answer Service



M 002

Q&A 2009-003

Published: 09 January 2009

Question:

Where is the starting area, how big is it, when does it exist and when does it cease to exist?

Answer:

The sailing instructions may define the starting area for a particular event, and may place restrictions on entering it. When the term is not explained in the sailing instructions, it has the meaning 'ordinarily understood in nautical or general use' (See Introduction to the Racing Rules of Sailing). The 'starting area' will normally be the area where boats will sail between their preparatory signal and starting signal.

When all boats in all the starts in a starting sequence have started and left the area around the starting line, the starting area ceases to exist unless something else is written into the rules for the event or races have been abandoned.

ISAF Racing Rules Question and Answer Service



M 003

Q&A 2009-018

Published: 26 January 2009

Situation:

A finishing line has two marks and two zones and a boat must pass between the marks.

Question 1:

Under the 2009 - 2012 rules, in particular rule 18.4, is a finishing line considered a 'gate'?

Answer 1:

No.

Question 2:

If the course is shortened at the leeward gate, is the finishing line a 'gate'?

Answer 2:

No. Rule 32.2 changes the marks of the gate into marks of the finishing line.

Rule 18.4 would only be relevant at a finishing mark when an inside overlapped right-of-way boat must gybe to sail her proper course.

ISAF Racing Rules Question and Answer Service



M 004

Q&A 2009-019

Published: 26 January 2009

Fetching A boat is *fetching a mark* when she is in a position to pass to windward of it and leave it on the required side without changing tack.

Question 1

Is there any distance limitation from the mark when the boat approaches it (let's say from one mile away)? Is she fetching the mark?

Answer 1

The definition Fetching does not include any distance limitation. A boat may be fetching a mark from one mile away.

In either of the two rules using the defined term Fetching, one boat must be fetching for that rule to apply between two boats. Whilst a boat may be fetching from a long distance, rules 18.3 and 20.3 will only become relevant if the boats referred to in the rule using the term are in close proximity to each other and a mark.

Question 2

Does the term "fetching" include only the approaching action of the boat from any distance?

Answer 2

The definition Fetching is based on a boat's position, and not on any action she is taking. It addresses a boat's ability to pass to windward of a mark from her current position. It is satisfied if the boat can pass to windward and on the required side of the mark without changing tack. The approach of the boat and how the boat passes the mark are the facts that a protest committee can use to determine if a boat was fetching the mark.

Question 3

Or does it include the action of passing the mark as well?

Answer 3

See the answer to question 2.

Question 4

If the answer to Question 3 is yes, does it include the whole rounding manoeuvre of the boat?

Answer 4

See the answer to question 2.

Question 5

If the answer to question 2 is yes, how and by whom can a dispute based on contradictory statements in a protest hearing be decided?

Answer 5

See the answer to question 2.

ISAF Racing Rules Question and Answer Service



M 005

Q&A 2009-032

Published: 23 June 2009

Question

When is a boat 'sailing on another leg' with relation to rule 23.2? Some guidance would be helpful for fleet, match and team racing.

Answer

For the purpose of a boat taking a penalty in match racing, rule C7.2(c) states when a leg has been completed. That rule only applies to match racing.

Rule 23.2 deals with two-boat situations under match, team and fleet racing rules, and applies on any type of course. Given that, to break rule 23.2, a boat must be sailing a course that is not her proper course, the exact moment when one leg ends and another begins at a mark is rarely likely to be an issue. ISAF Team Racing Rapid Response Call 2009/007 offers useful guidance, including the statement that will usually apply when the breach is clear, namely that, after the starting signal, a boat that passes the wrong side of a mark is not on the same leg of the course as a boat that is passing the mark on the required side.

When a keep-clear boat may have broken rule 23.2, she will usually also have broken a rule of Section A, rule 14 or a rule of Section C. Therefore, the question as to whether a boat has broken rule 23.2 alone is likely to arise only with respect to a right-of-way boat.

ISAF Racing Rules Question and Answer Service



M 006

Q&A 2010-19

Published: 26 May 2010

Question:

As a boat without speed sheets on to move forwards she initially drifts side-ways. Is this action considered a change of course under rule 16?

Answer:

A boat moving from a stopped position to sailing in a direction would not be considered to be changing course, except when she went from having sailed backwards to sailing forwards or vice versa. (See Match Racing Call UMP 35).

In order for rule 16 to apply, there would need to be two boats and the right-of-way boat would need to be changing course.

ISAF Racing Rules Question and Answer Service



M 007

Q&A 2010-22

Published: 9 June 2010

The sailing instructions at an event describe the starting mark as 'a buoy with an orange flag'.

Question 1:

While racing, a boat touches the flag only, not the staff or the buoy itself. Has the boat broken rule 31?

Answer 1:

Yes.

Question 2:

Would the answer be different if the sailing instructions mentioned the buoy but not the flag?

Answer 2:

No. The flag attached to the buoy is not an object attached temporarily or accidentally to the mark and is therefore part of the mark in accordance with the definition Mark.

ISAF Racing Rules Question and Answer Service



M 008

Q&A 2010-26

Published: 6 July 2010

Situation 1

The test for whether a boat's single action breaks rule 42.1 Basic Rule is Interpretation BASIC 4, the 'Paddle Test'.

Rule 42.1 allows for exceptions when it begins, 'Except when permitted in rule 42.3 or 45, ...'

One of the exceptions is when surfing or planing is possible. Rule 42.3(c) permits a single pull of a sheet or guy to initiate surfing or planing

Question 1

Is there any limitation, for instance the BASIC 4 'Paddle Test', on this single pull of a sheet or guy?

Answer 1

There is no limitation with respect to Basic 4, however rule 42.3(c) limits the acceleration to what is required to make the boat plane or surf. Therefore, the amount of acceleration must be consistent with the initiating of surfing or planing.

Situation 2

The Interpretations define a roll as '... a single-cycle athwartship movement of the boat ...'.

A roll that facilitates steering is also an exception to rule 42.1 under rule 42.3(a).

A single-cycle athwartship movement to leeward to facilitate a turn and back to windward when the turn is complete might happen at the start when turning up to a close-hauled course, when rounding a leeward mark or when turning upwind after ducking a boat.

Question 2

Is there any limitation, for instance the BASIC 4 'Paddle Test', on this single roll?

Answer 2

There is no limitation with respect to Basic 4, however rule 42.3 (a) limits the roll to what is required to help steer the boat. Therefore the amount of rolling must be consistent with the amount the boat turns.

ISAF Racing Rules Question and Answer Service



M 009

Q&A 2010-27

Published: 7 July 2010

Situation

Two boats, W and L, are sailing downwind in conditions where they would normally use spinnakers to finish as soon as possible.

Boat W has a problem with her spinnaker and boat L, sailing faster, establishes a leeward overlap from clear astern and is subject to rule 17. Boat L decides not to use her spinnaker to gain a tactical advantage over W.

Both boats are sailing their fastest VMG course for a boat sailing downwind with a headsail but they are sailing a higher course than they would be able to sail if using their spinnakers.

Boat W protests boat L alleging she is sailing above her proper course as the definition Proper Course requires her to sail to finish as soon as possible. In the absence of boat W, L would have hoisted her spinnaker and sailed a faster and lower course to finish as soon as possible

Question

Does boat L break rule 17 by not hoisting her spinnaker and not sailing a lower, faster course in order to finish as soon as possible?

Answer

No. The rules have no requirement as to which sails a boat must use at any time and a boat's proper course is the course she would sail to finish as soon as possible in the conditions and with the sails she has set. Nor is there any requirement in the rules for a boat to finish as soon as possible and there could be a variety of reasons why a boat would not use a spinnaker, including tactical considerations. (See ISAF Case 78).

ISAF Racing Rules Question and Answer Service



Section N

Prescriptions and other rules

- N1** National prescriptions not complying with rule 86.1(a)
- N2** Approval for appointment of protest committees

Other Questions that may be relevant:

J5, M8

ISAF Racing Rules Question and Answer Service



N 001

Q&A 2010-007

Published: 15 February 2010

Situation:

In the provisions for all racing in a country, a national authority states in the chapter about appeals:

‘No appeals are possible for races under Yardstick or another appropriate rating system if the protests and the decisions made by the protest committee are related to the relevant rating formula or the relevant rating system.’

Note: Neither an International Jury nor rule 86.3 is mentioned, nor are those races, races as mentioned in rules 70.5(b) or 70.5(c).

Question:

Does rule 86.3 make this a valid prescription to rule 70 for an event where the right to appeal is not denied by some other rule?

Answer:

It is unclear whether this provision is a prescription of the national authority. If it is, it does not concern the development or testing of a proposed rule, and therefore it does not fulfil the requirement of rule 86.3. Nor is it a valid general prescription, since rule 86.1(a) says that a prescription cannot change rule 70.

If this provision is not a prescription but is contained in another document governing the event according to the notice of race and/or the sailing instructions, it is changing a rule contrary to rule 86.1(a) that says the only method by which a national authority may change a rule is by a prescription.

In either case, therefore, the provision does not validly deny the right of appeal.

ISAF Racing Rules Question and Answer Service



N 002

Q&A 2010-14

Published: 19 April 2010

Question

Does a national authority have the right to prescribe that its approval is required for the appointment of a protest committee for races within its jurisdiction?

Answer

No. An addition to a rule is a change of a rule (see Terminology in the Introduction to the Racing Rules of Sailing). Rule 91(a) is a rule of Part 7 and rule 86.1(a) makes it clear that prescriptions cannot change a rule of Part 7.

This is different from rule 91(b), where a specific exception in the rule itself actually permits a national authority to prescribe that its approval is required for the appointment for an international jury for races within its jurisdiction (with some exceptions).

ISAF Racing Rules Question and Answer Service



Deleted Q&A's 2009

The following Q&A's have been removed from the ISAF website and been deleted with effect of 1 January 2009.

2007-002
2007-005
2007-007

2006-001
2006-004

2005-002
2005-004
2005-005
2005-007

2004-003

2003-008

2001-005

And with effect of 20 April 2008
2005-001

And with effect of 1 January 2010
2009-20
2009-24

Contents by Numbers – Including New Names

<i>Number</i>	<i>about</i>	<i>Names</i>
Q&A 01-001	A question relating to the time limit of races.	F 1
Q&A 02-001	Rule N1.1 and International Jury members on signal and finishing boats.	H 1
Q&A 03-001	A question relating to International Juries and when they are properly constituted	H 2
Q&A 03-002	Scoring boats OCS after the race based on observations by or statements from competitors or other persons outside the race committee.	F 2
Q&A 03-004	Abandoning a race after some of the boats have finished.	F 3
Q&A 03-007	A question about the legality of disconnecting the headstay while racing.	K 1
Q&A 04-006	When is a boat on a beat to windward?	M 1
Q&A 04-008	Signalling a yellow flag penalty after a general recall.	J 1
Q&A 06-002	When has a boat 'cleared' the finishing line and marks?	E 1
Q&A 06-003	Race committee action when a boat passes the pin end of the finishing line on the wrong side or touches a finishing mark.	E 2
Q&A 06-005	A collision between two catamarans on opposite tacks at a narrow gate.	B 1
Q&A 07-001	Awarding of average points in multiple races.	F 4
Q&A 07-003	A clarification of fetching at the finishing mark.	E 3
Q&A 07-004	A clarification about rule 30.1, I Flag Rule (Called Round-an-End Rule)	C 1
Q&A 07-006	Notifying boats of a protest by informing the coach, rules advisor or other representative.	J 2
Q&A 07-008	Slowing another boat's progress in a race.	A 1
Q&A 08-001	A clarification about numbering of races.	F 5
Q&A 08-002	'Normal position' - finishing as a capsized boat.	E 4
Q&A 08-003	A discussion about whether a boat that has retired can un-retire.	F 6
Q&A 08-004	A question about the use of the Yngling gybing line.	K 2
Q&A 09-001	A question about boat wax/polish and rule 53.	K 3

Q&A 09-002	A clarification of 'number of boats entered in a series' for the purpose of scoring under Appendix A.	F 7
Q&A 09-003	Questions about the term 'Starting Area'.	M 2
Q&A 09-004	'Keeping Clear' in a windward /leeward situation.	B 2
Q&A 09-005	Relating to ISAF Case 45 - a case about a sailing instruction that required boats to finish contrary to the definition 'Finish'.	E 5
Q&A 09-006	A clarification of rule 90.3(a): A race cannot be scored when no boats have sailed the course in compliance with rule 28 and finished.	F 8
Q&A 09-007	A question about hiking devices and rule 49.1.	K 4
Q&A 09-008	'Side of a mark' for the purpose of rule 28.	D 1
Q&A 09-009	Special sailing instruction to allow shortening races for safety reasons even after some boats have crossed the finishing line.	G 1
Q&A 09-010	A boat forced to the wrong side of a mark still needs to sail correctly around that mark. She is not 'compelled' to break rule 28.	D 2
Q&A 09-011	The weighing and credibility of evidence in protest hearings.	J 3
Q&A 09-012	When the race committee observes a boat touching a mark.	G 2
Q&A 09-013	Scoring series with multiple rankings.	F 9
Q&A 09-014	A clarification of rule 28. A catamaran rounding a mark with one hull flying over the mark.	D 3
Q&A 09-015	About abandonment in match racing. Where to draw the line for what would be an improper action by the race committee.	G 4 and K 1
Q&A 09-016	About shortening of course, finishing when the race committee is positioned at the 'wrong' end of the line.	E 6
Q&A 09-017	When Mark-Room includes room to tack.	B 3
Q&A 09-018	Is a finishing line a 'gate'?	M 3
Q&A 09-019	Questions about the new definition Fetching.	M 4
Q&A 09-021	Rights and obligations at obstructions.	B 4
Q&A 09-022	How much room is mark-room?	B 5
Q&A 09-023	A discussion about different aspects of a situation when a boat learns, in an invalid hearing, that she has broken a rule.	A 2
Q&A 09-025	Questions about the windward mark and proper course.	B 6

Q&A 09-026	When does a boat finish – when is the line a finishing line.	E 7
Q&A 09-027	When boats start in both directions – what should be done?	C 2
Q&A 09-028	Obligations when a boat hails for room to tack.	B 7
Q&A 09-029	A question about rule 53, textured surfaces and wet sanding.	K 5
Q&A 09-030	A clarification about rule 18.3.	B 8
Q&A 09-031	How may scoring mistakes be corrected after a regatta?	F 10
Q&A 09-032	When is a boat 'sailing on another leg'?	M 5
Q&A 09-033	How early must a boat start taking action to avoid a collision?	B 9
Q&A 09-034	When one Gate Mark is missing.	D 4
Q&A 09-035	About Case 112 and Q&A 2009-26.	E 8
Q&A 09-036	When does rule 18.3 stop applying?	B 10
Q&A 09-037	Questions about rule 42 when rules 49 to 54 do not apply	K 6
Q&A 09-038	Using a lead trapeze harness strap buckle (that is a dive weight) and rule 43.1(a).	K 7
Q&A 09-039	When a protest committee protests a boat under rule 60.3(a)(2).	J 4
Q&A 09-040	About denial of appeal and national prescriptions.	J 5
Q&A 09-041	A clarification about submitting questions about Jury decisions.	H 3
Q&A 10-001	3 boats overlapped on port tack approaching an obstruction; a racing boat on starboard tack.	B 11
Q&A 10-002	Life line material and the Racing Rules of Sailing.	K 8
Q&A 10-003	Compelled to break a rule by an unidentified boat breaking a rule.	J 6
Q&A 10-004	About touching marks and the definitions Finish and Racing.	D 5
Q&A 10-005	Conditions for a protest committee to reinstate an abandoned race.	J 7
Q&A 10-006	Protest time limit when the race time limit runs out.	J 8
Q&A 10-007	National prescriptions not complying with rule 86.1(a).	O 1
Q&A 10-008	Redress when boats get entangled with marks.	J 9
Q&A 10-009	Finishing mark and rules 18.2 and 18.5.	B 12
Q&A 10-010	Posting OCS lists at the windward mark.	G 3

Q&A 10-011	Overlap changing from leeward to windward overlap.	B 13
Q&A 10-012	Rule 18.3 and 'causing a boat to sail above close-hauled'.	B 14
Q&A 10-013	Rules 19 and 20 when multiple boats meet.	B 15
Q&A 10-014	Approval for appointment of protest committees.	N 02
Q&A 10-015	Changing the meaning of the Race Signals in the sailing instructions.	G 05
Q&A 10-016	When sailing clubs mix responsibilities for club regattas.	G 06
Q&A 10-017	Windward boat must always keep clear.	B 16
Q&A 10-018	Race committee procedures for sighting the starting line.	G 07
Q&A 10-019	Changing course and rule 16.	M 06
Q&A10-020	Two boats tacking in the zone when another is fetching.	B 17
Q&A 10-021	When using VHF to recall boats.	G 08
Q&A 10-022	When touching only the flag on a mark.	M 07
Q&A 10-023	Resolving ties in series score when redress is involved.	F 11
Q&A 10-024	The rights of an OCS boat that is sailing the course.	D 06
Q&A 10-025	Clarifications about Mark-Room and rule 18.3.	B 18
Q&A 10-026	Paddle test and the exceptions in rule 42.	M 08
Q&A 10-027	Proper Course and sail configuration.	M 09